

Chapter 3

Transport Layer



Chapter 3: Transport Layer

our goals:

- understand principles behind transport layer services:
 - multiplexing, demultiplexing
 - reliable data transfer
 - flow control
 - congestion control
- learn about Internet transport layer protocols:
 - UDP: connectionless transport
 - TCP: connection-oriented reliable transport
 - TCP congestion control

Chapter 3 outline

3.1 transport-layer services

3.2 multiplexing and demultiplexing

3.3 connectionless transport: UDP

3.4 principles of reliable data transfer

3.5 connection-oriented transport: TCP

- segment structure
- reliable data transfer
- flow control
- connection management

3.6 principles of congestion control

3.7 TCP congestion control

Transport services and protocols

- provide *logical communication* between app processes running on different hosts
- transport protocols run in end systems
 - send side: breaks app messages into *segments*, passes to network layer
 - rcv side: reassembles segments into messages, passes to app layer
- more than one transport protocol available to apps
 - Internet: TCP and UDP

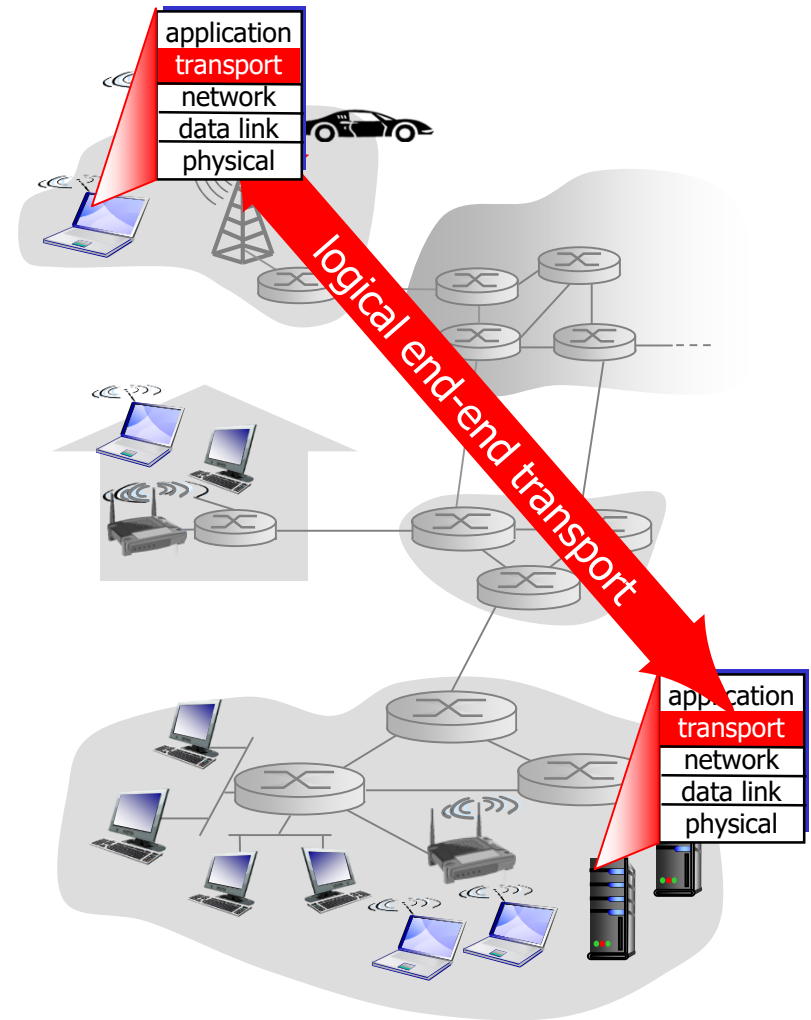

Transport vs. network layer

- *network layer*: logical communication between hosts
- *transport layer*: logical communication between processes
 - relies on, enhances, network layer services

household analogy:

12 kids in Ann's house sending letters to 12 kids in Bill's house:

- hosts = houses
- processes = kids
- app messages = letters in envelopes
- transport protocol = Ann and Bill who demux to in-house siblings
- network-layer protocol = postal service

Internet transport-layer protocols

- reliable, in-order delivery (TCP)
 - congestion control
 - flow control
 - connection setup
- unreliable, unordered delivery: UDP
 - no-frills extension of “best-effort” IP
- services not available:
 - delay guarantees
 - bandwidth guarantees

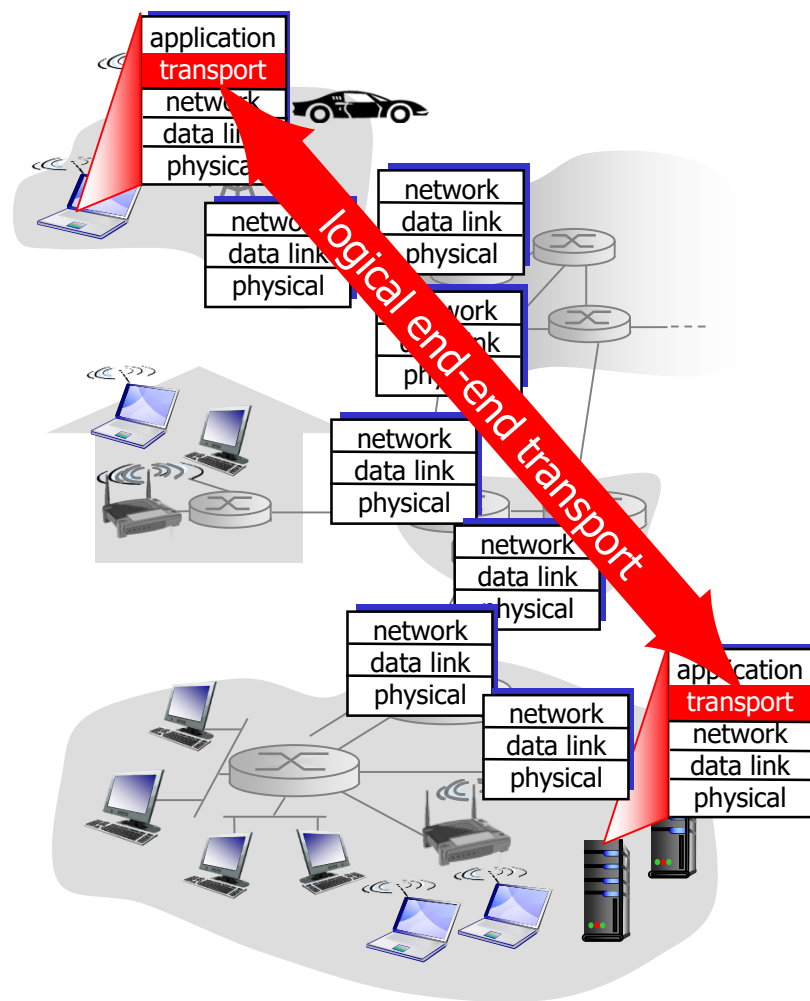

Chapter 3 outline

3.1 transport-layer services

3.2 multiplexing and demultiplexing

3.3 connectionless transport: UDP

3.4 principles of reliable data transfer

3.5 connection-oriented transport: TCP

- segment structure
- reliable data transfer
- flow control
- connection management

3.6 principles of congestion control

3.7 TCP congestion control

Multiplexing/demultiplexing

multiplexing at sender:
handle data from multiple sockets, add transport header (later used for demultiplexing)

demultiplexing at receiver:
use header info to deliver received segments to correct socket

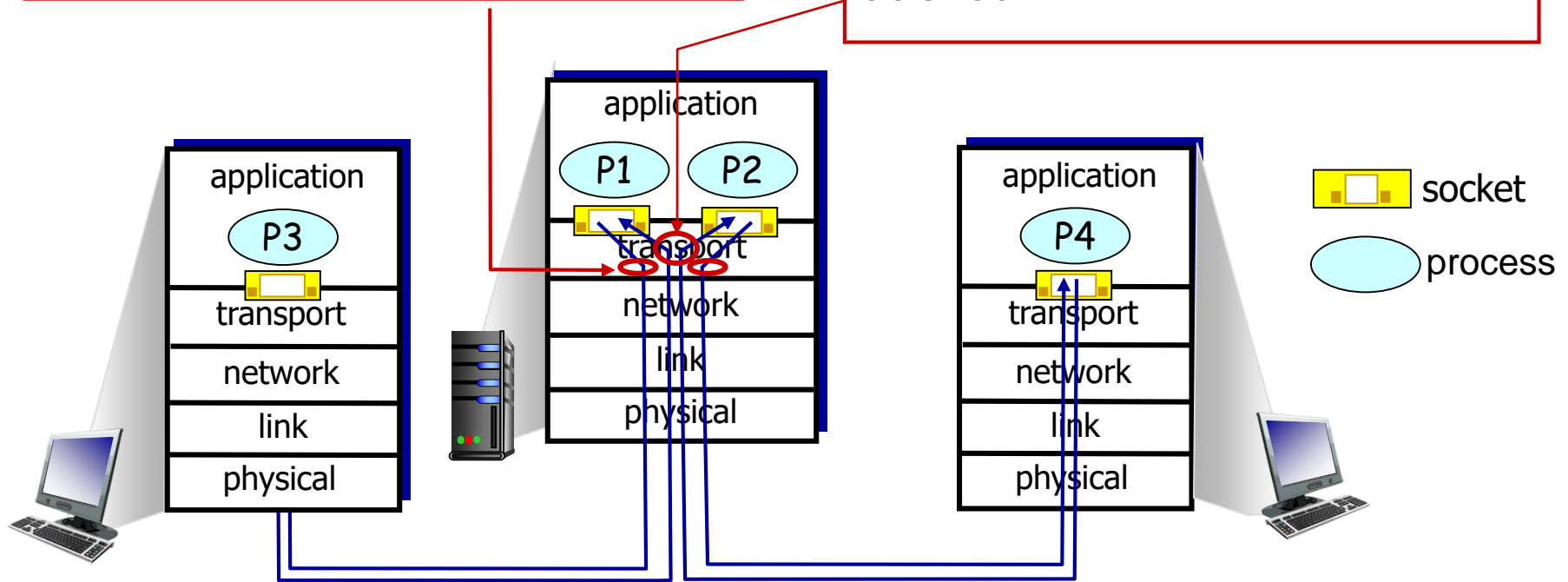

How demultiplexing works

- host receives IP datagrams
 - each datagram has source IP address, destination IP address
 - each datagram carries one transport-layer segment
 - each segment has source, destination port number
- host uses *IP addresses & port numbers* to direct segment to appropriate socket

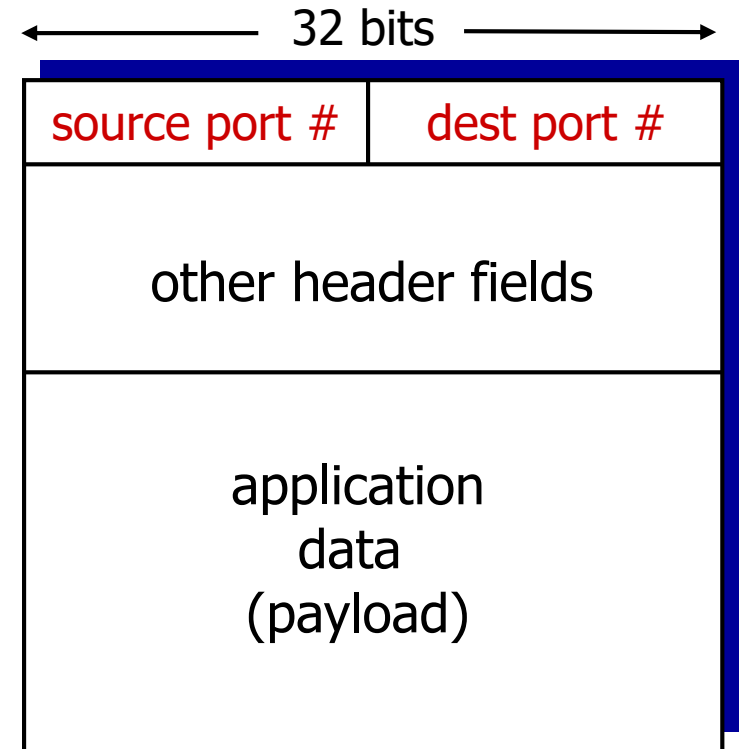

TCP/UDP segment format

Connectionless demultiplexing

- *recall*: created socket has host-local port #:

```
DatagramSocket mySocket1  
= new DatagramSocket(12534);
```

- *recall*: when creating datagram to send into UDP socket, must specify

- destination IP address
- destination port #

-
- when host receives UDP segment:

- checks destination port # in segment
- directs UDP segment to socket with that port #



IP datagrams with *same dest. port #*, but different source IP addresses and/or source port numbers will be directed to *same socket* at dest

Connectionless demux: example

```
DatagramSocket  
mySocket2 = new  
DatagramSocket  
(9157);
```

```
DatagramSocket  
serverSocket = new  
DatagramSocket  
(6428);
```

```
DatagramSocket  
mySocket1 = new  
DatagramSocket  
(5775);
```

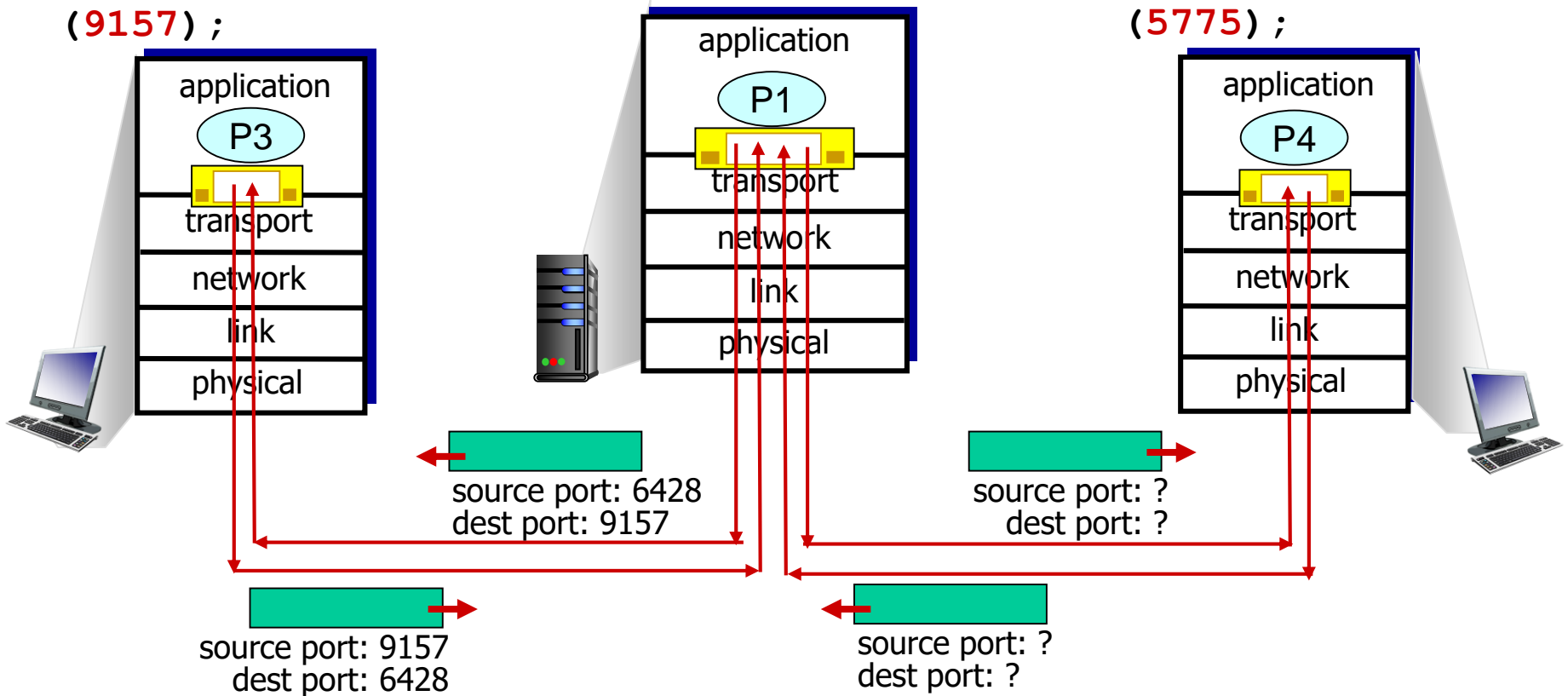

Connection-oriented demux

- TCP socket identified by 4-tuple:
 - source IP address
 - source port number
 - dest IP address
 - dest port number
- demux: receiver uses all four values to direct segment to appropriate socket
- server host may support many simultaneous TCP sockets:
 - each socket identified by its own 4-tuple
- web servers have different sockets for each connecting client
 - non-persistent HTTP will have different socket for each request

Connection-oriented demux: example

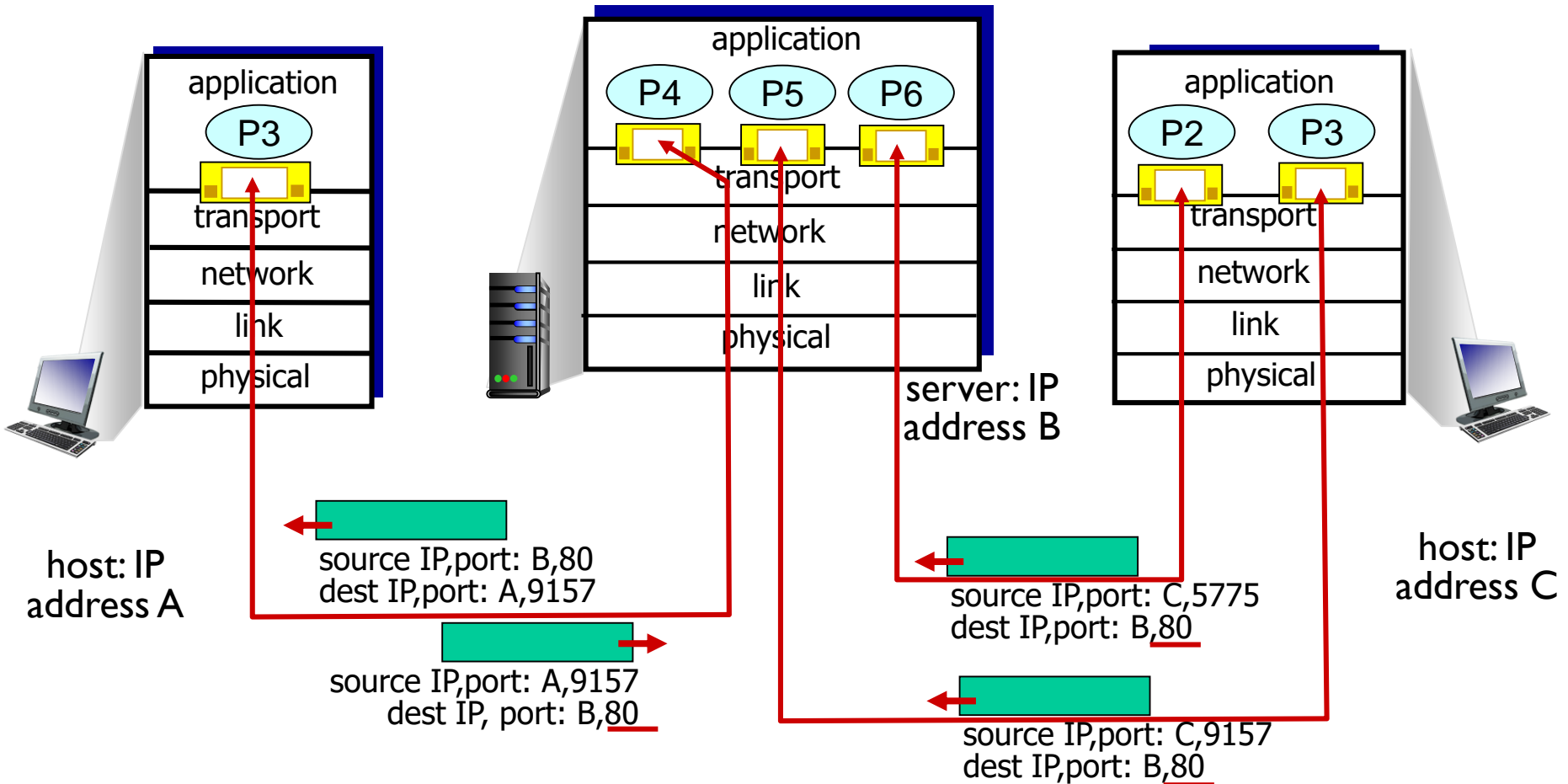

three segments, all destined to IP address: B,
dest port: 80 are demultiplexed to *different* sockets

Connection-oriented demux: example

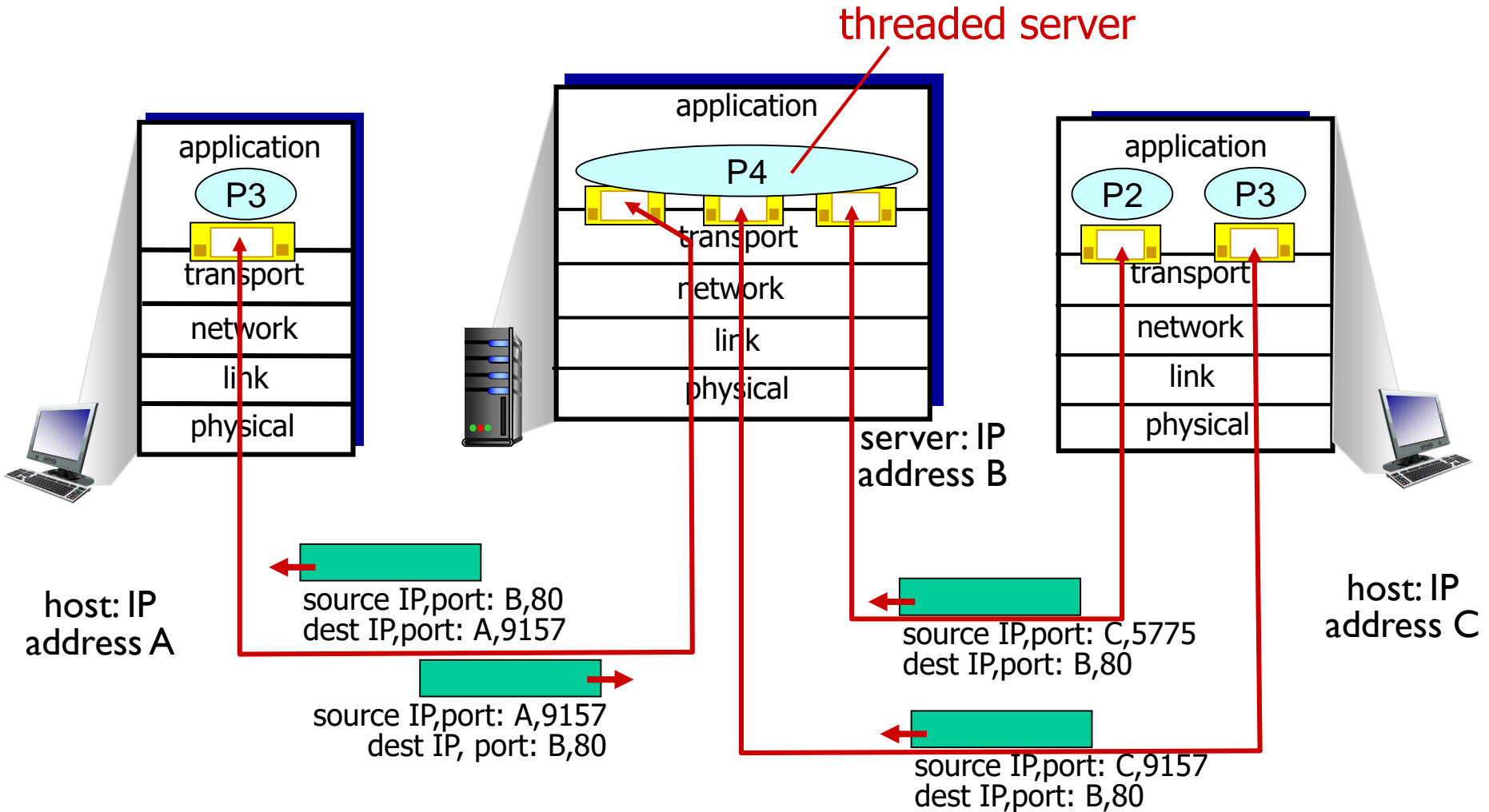

Chapter 3 outline

3.1 transport-layer services

3.2 multiplexing and demultiplexing

3.3 connectionless transport: UDP

3.4 principles of reliable data transfer

3.5 connection-oriented transport: TCP

- segment structure
- reliable data transfer
- flow control
- connection management

3.6 principles of congestion control

3.7 TCP congestion control

UDP: User Datagram Protocol [RFC 768]

- “no frills,” “bare bones”
Internet transport protocol
- “best effort” service, UDP segments may be:
 - lost
 - delivered out-of-order to app
- *connectionless*:
 - no handshaking between UDP sender, receiver
 - each UDP segment handled independently of others
- UDP use:
 - streaming multimedia apps (loss tolerant, rate sensitive)
 - DNS
 - SNMP
- reliable transfer over UDP:
 - add reliability at application layer
 - application-specific error recovery!

UDP: segment header

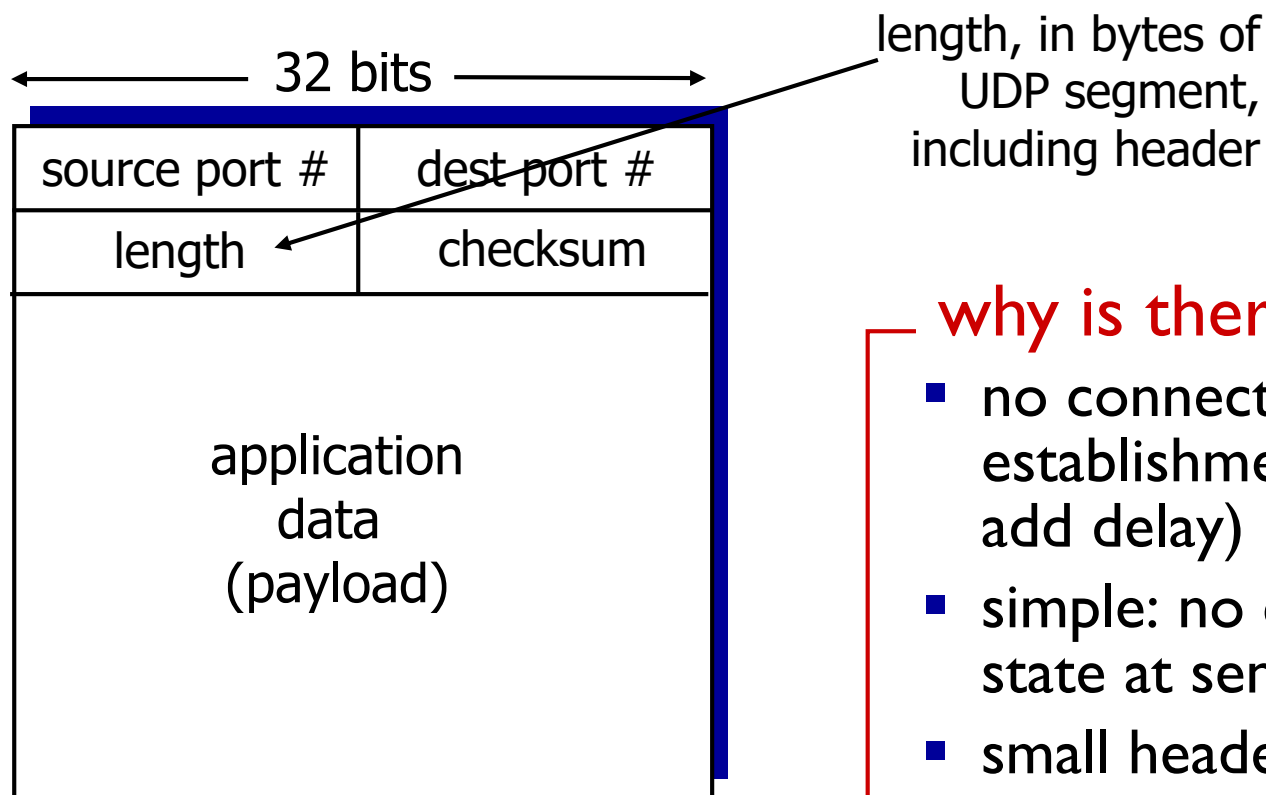

UDP segment format

why is there a UDP?

- no connection establishment (which can add delay)
- simple: no connection state at sender, receiver
- small header size
- no congestion control: UDP can blast away as fast as desired

UDP checksum

Goal: detect “errors” (e.g., flipped bits) in transmitted segment

sender:

- treat segment contents, including header fields, as sequence of 16-bit integers
- checksum: addition (one’s complement sum) of segment contents
- sender puts checksum value into UDP checksum field

receiver:

- compute checksum of received segment
- check if computed checksum equals checksum field value:
 - NO - error detected
 - YES - no error detected.
But maybe errors nonetheless? More later
....

Internet checksum: example

example: add two 16-bit integers

	1	1	1	0	0	1	1	0	0	1	1	0	0	1	1	0	
	1	1	0	1	0	1	0	1	0	1	0	1	0	1	0	1	
<hr/>																	
wraparound	1	1	0	1	1	1	0	1	1	1	0	1	1	1	0	1	1
<hr/>																	
sum	1	0	1	1	1	0	1	1	1	0	1	1	1	1	0	0	
checksum	0	1	0	0	0	1	0	0	0	1	0	0	0	0	1	1	

Note: when adding numbers, a carryout from the most significant bit needs to be added to the result

Chapter 3 outline

3.1 transport-layer services

3.2 multiplexing and demultiplexing

3.3 connectionless transport: UDP

3.4 principles of reliable data transfer

3.5 connection-oriented transport: TCP

- segment structure
- reliable data transfer
- flow control
- connection management

3.6 principles of congestion control

3.7 TCP congestion control

Principles of reliable data transfer

- important in application, transport, link layers
 - top-10 list of important networking topics!

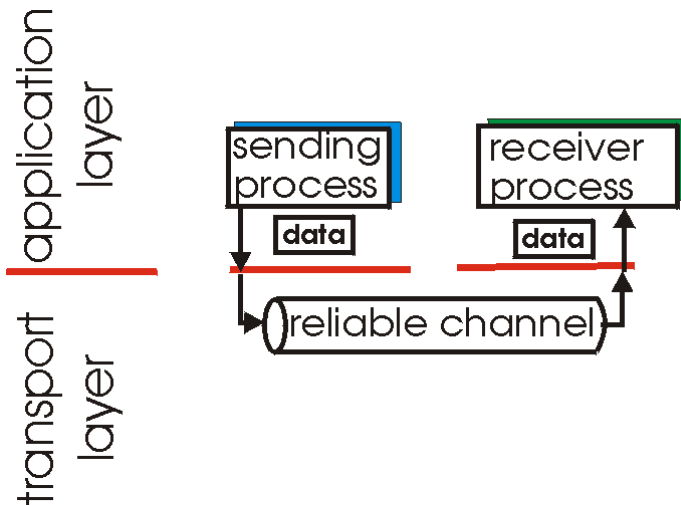

(a) provided service

- characteristics of unreliable channel will determine complexity of reliable data transfer protocol (rdt)

Principles of reliable data transfer

- important in application, transport, link layers
 - top-10 list of important networking topics!

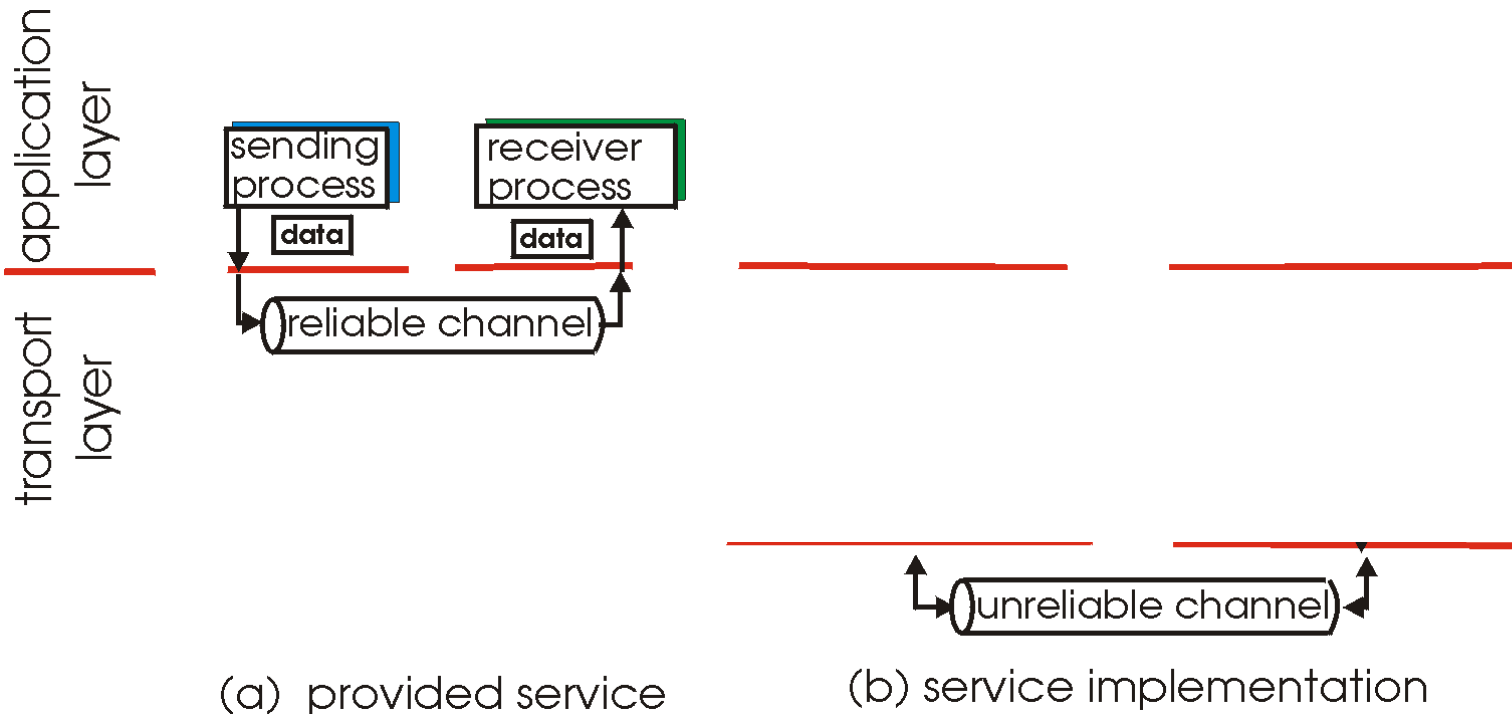

- characteristics of unreliable channel will determine complexity of reliable data transfer protocol (rdt)

Principles of reliable data transfer

- important in application, transport, link layers
 - top-10 list of important networking topics!

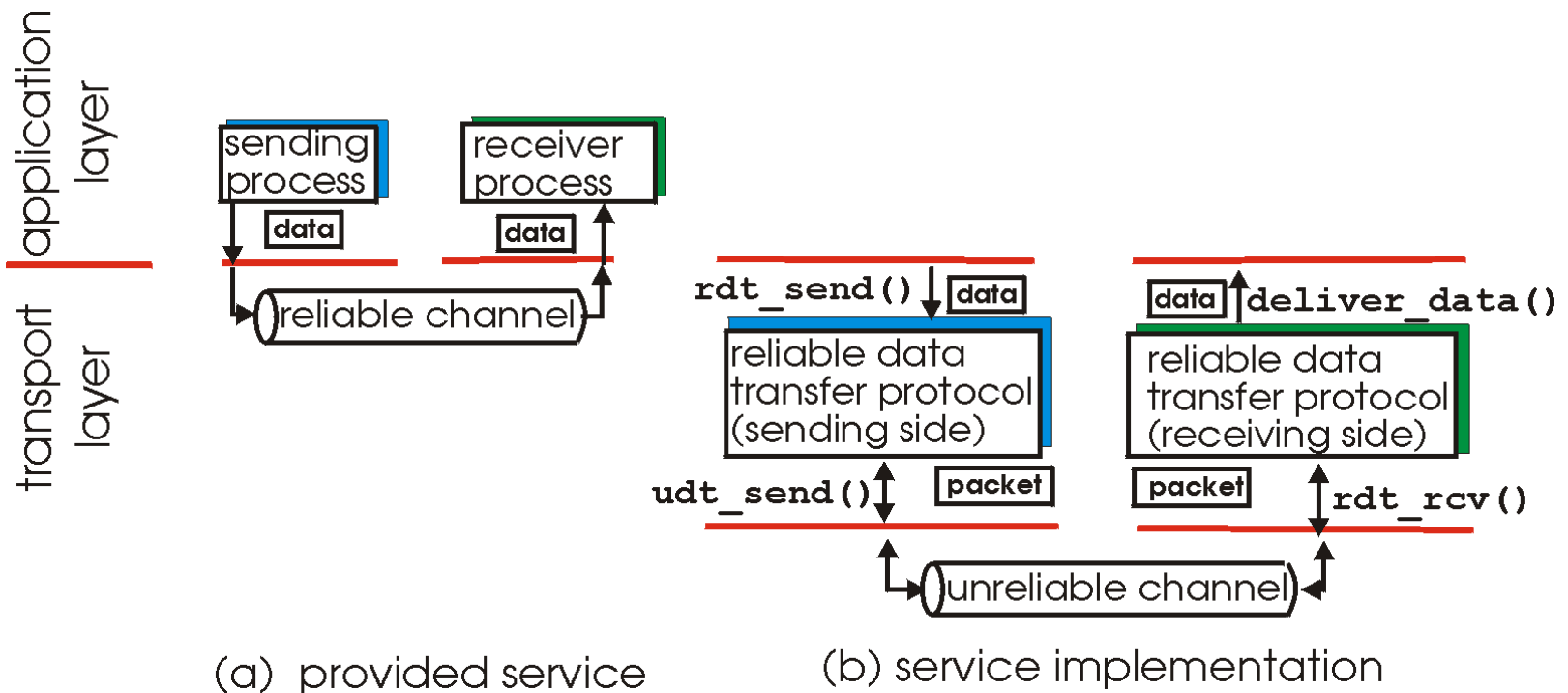

- characteristics of unreliable channel will determine complexity of reliable data transfer protocol (rdt)

Reliable data transfer: getting started

rdt_send() : called from above, (e.g., by app.). Passed data to deliver to receiver upper layer

deliver_data() : called by **rdt** to deliver data to upper

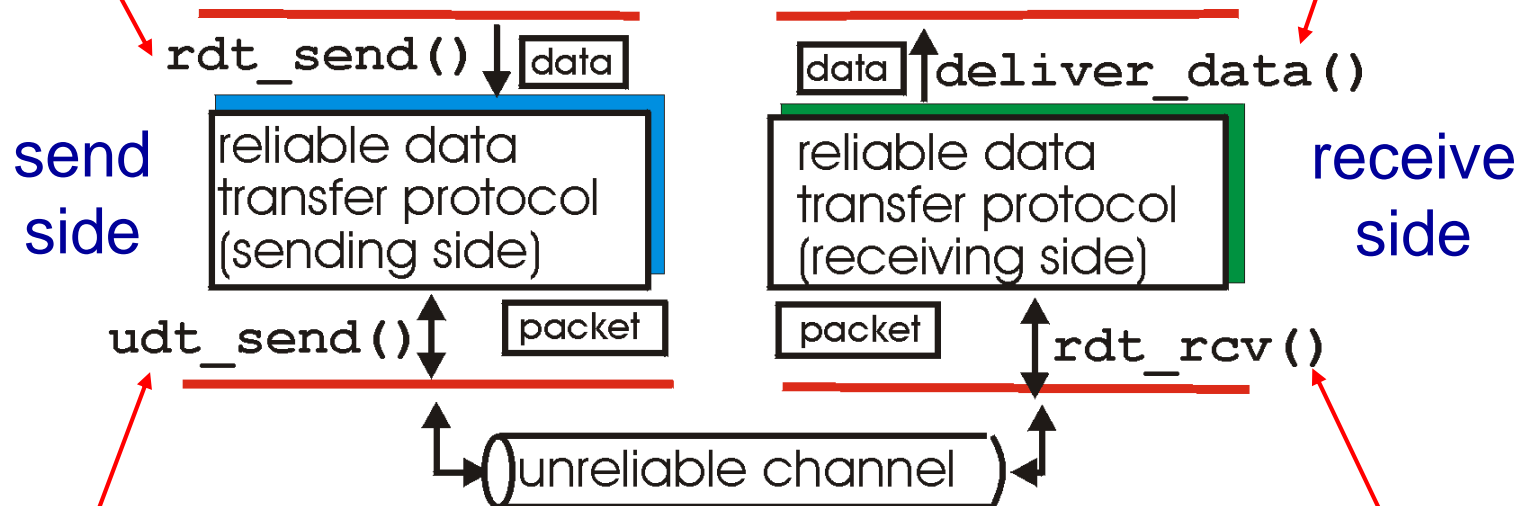

udt_send() : called by rdt, to transfer packet over unreliable channel to receiver

rdt_rcv() : called when packet arrives on rcv-side of channel

Reliable data transfer: getting started

we' ll:

- incrementally develop sender, receiver sides of reliable data transfer protocol (rdt)
- consider only unidirectional data transfer
 - but control info will flow on both directions!
- use finite state machines (FSM) to specify sender, receiver

state: when in this “state” next state uniquely determined by next event

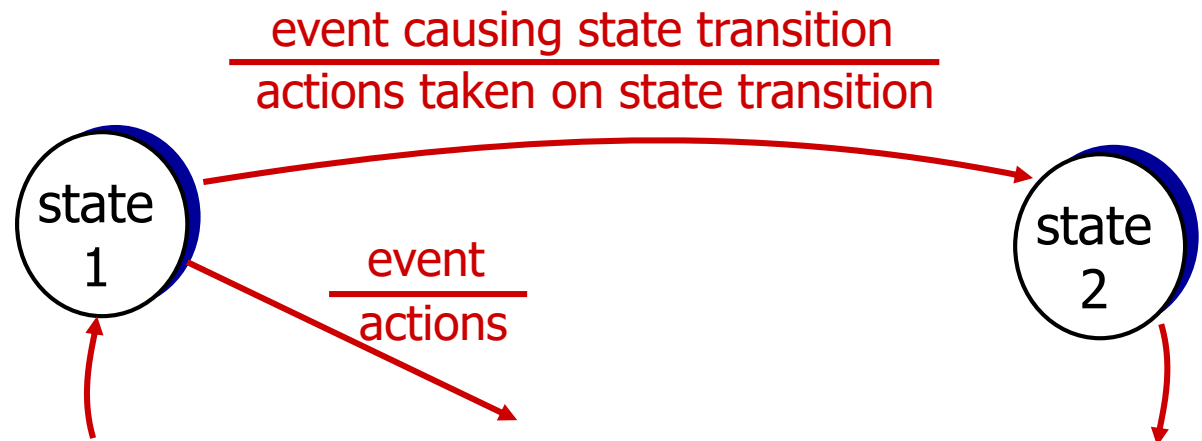

rdt 1.0: reliable transfer over a reliable channel

- underlying channel perfectly reliable
 - no bit errors
 - no loss of packets
- separate FSMs for sender, receiver:
 - sender sends data into underlying channel
 - receiver reads data from underlying channel

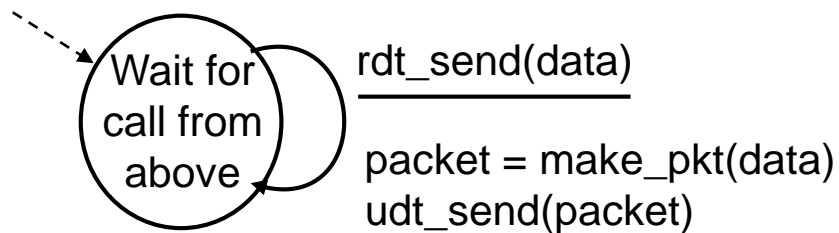

sender

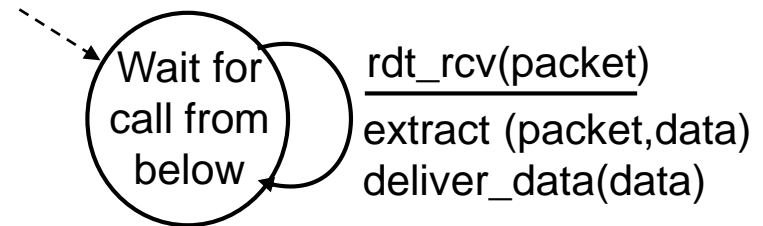

receiver

rdt2.0: channel with bit errors

- underlying channel may flip bits in packet
 - checksum to detect bit errors
- *the question*: how to recover from errors:

*How do humans recover from “errors”
during conversation?*

rdt2.0: channel with bit errors

- underlying channel may flip bits in packet
 - checksum to detect bit errors
- *the question*: how to recover from errors:
 - *acknowledgements (ACKs)*: receiver explicitly tells sender that pkt received OK
 - *negative acknowledgements (NAKs)*: receiver explicitly tells sender that pkt had errors
 - sender retransmits pkt on receipt of NAK
- new mechanisms in `rdt2.0` (beyond `rdt1.0`):
 - error detection
 - feedback: control msgs (ACK,NAK) from receiver to sender

rdt2.0: FSM specification

rdt_send(data)

sndpkt = make_pkt(data, checksum)

udt_send(sndpkt)

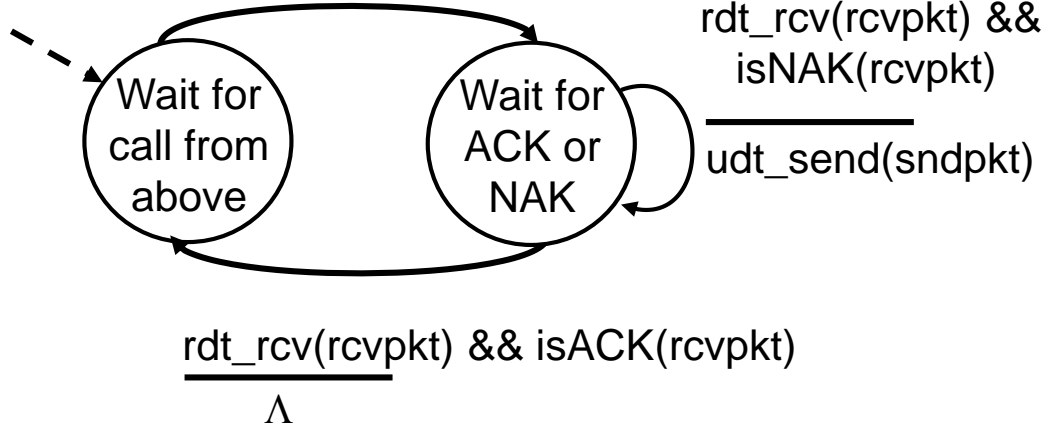

sender

receiver

rdt_rcv(rcvpkt) && corrupt(rcvpkt)
udt_send(NAK)

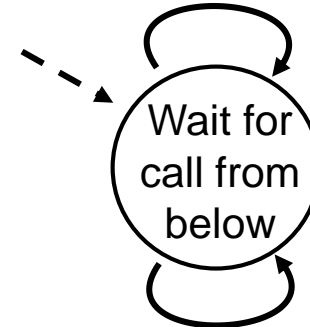

rdt_rcv(rcvpkt) && notcorrupt(rcvpkt)
extract(rcvpkt,data)
deliver_data(data)
udt_send(ACK)

rdt2.0: operation with no errors

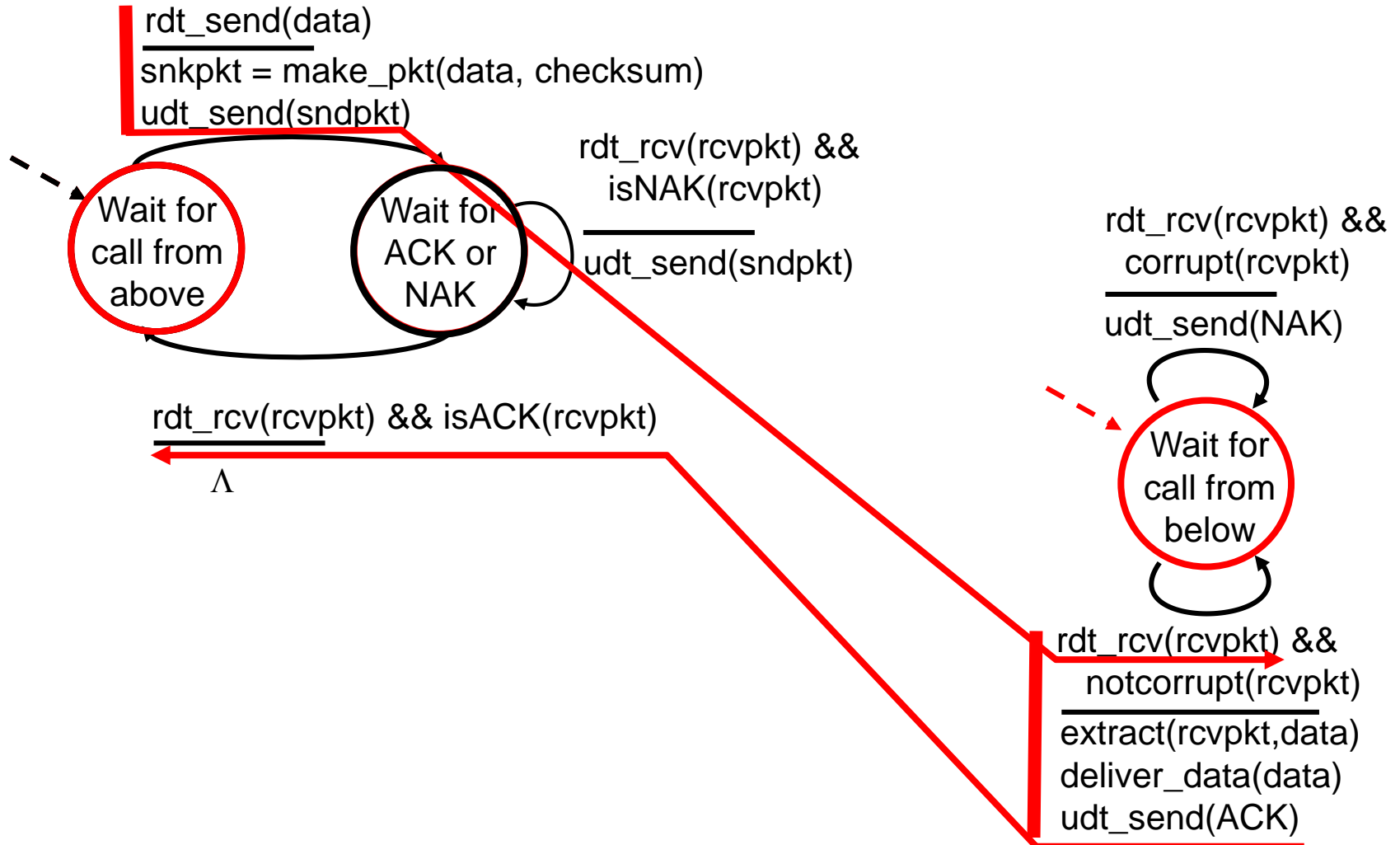

rdt2.0: error scenario

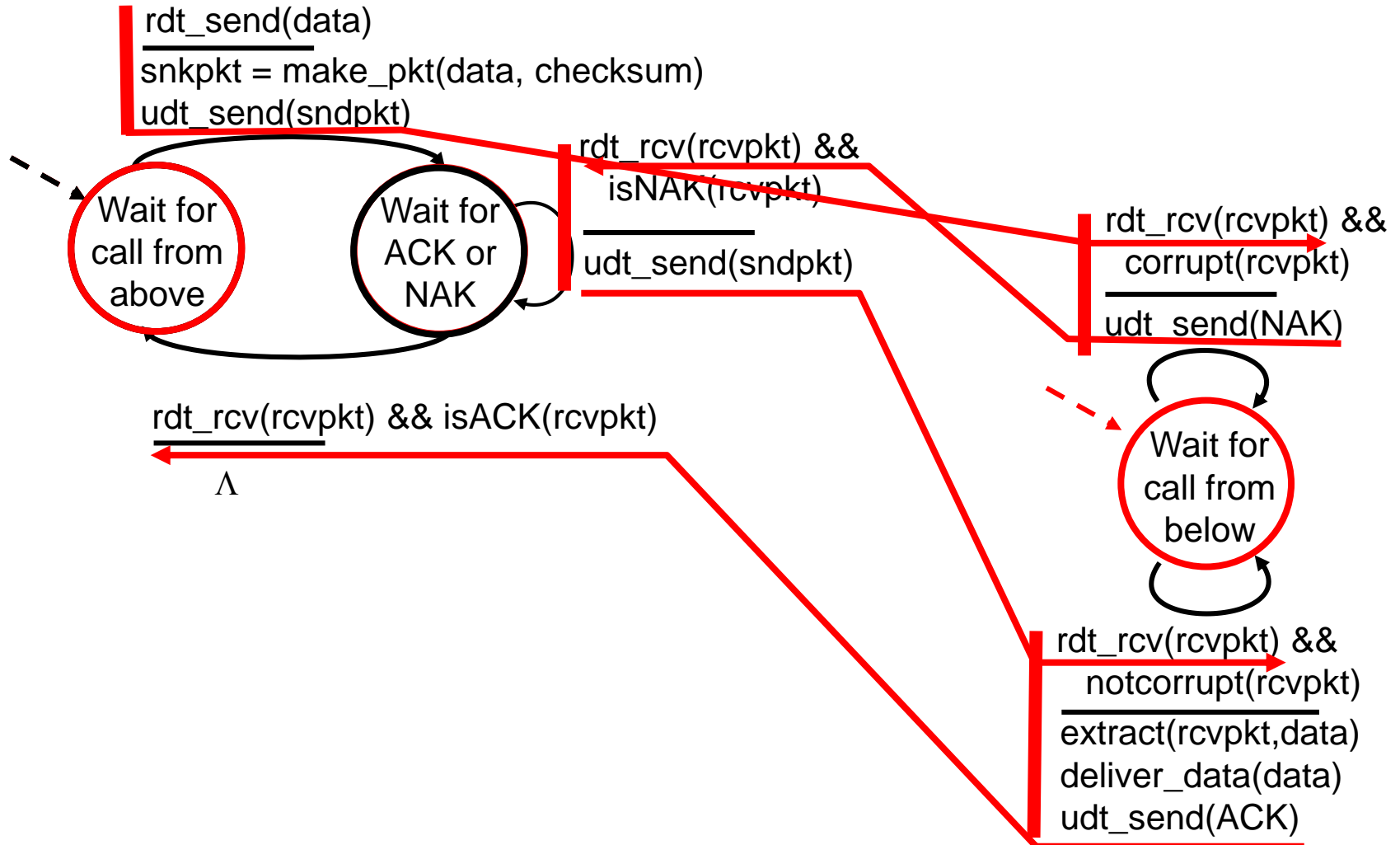

rdt2.0 has a fatal flaw!

what happens if ACK/NAK corrupted?

- sender doesn't know what happened at receiver!
- can't just retransmit: possible duplicate

handling duplicates:

- sender retransmits current pkt if ACK/NAK corrupted
- sender adds *sequence number* to each pkt
- receiver discards (doesn't deliver up) duplicate pkt

stop and wait

sender sends one packet,
then waits for receiver
response

rdt2.1: sender, handles garbled ACK/NAKs

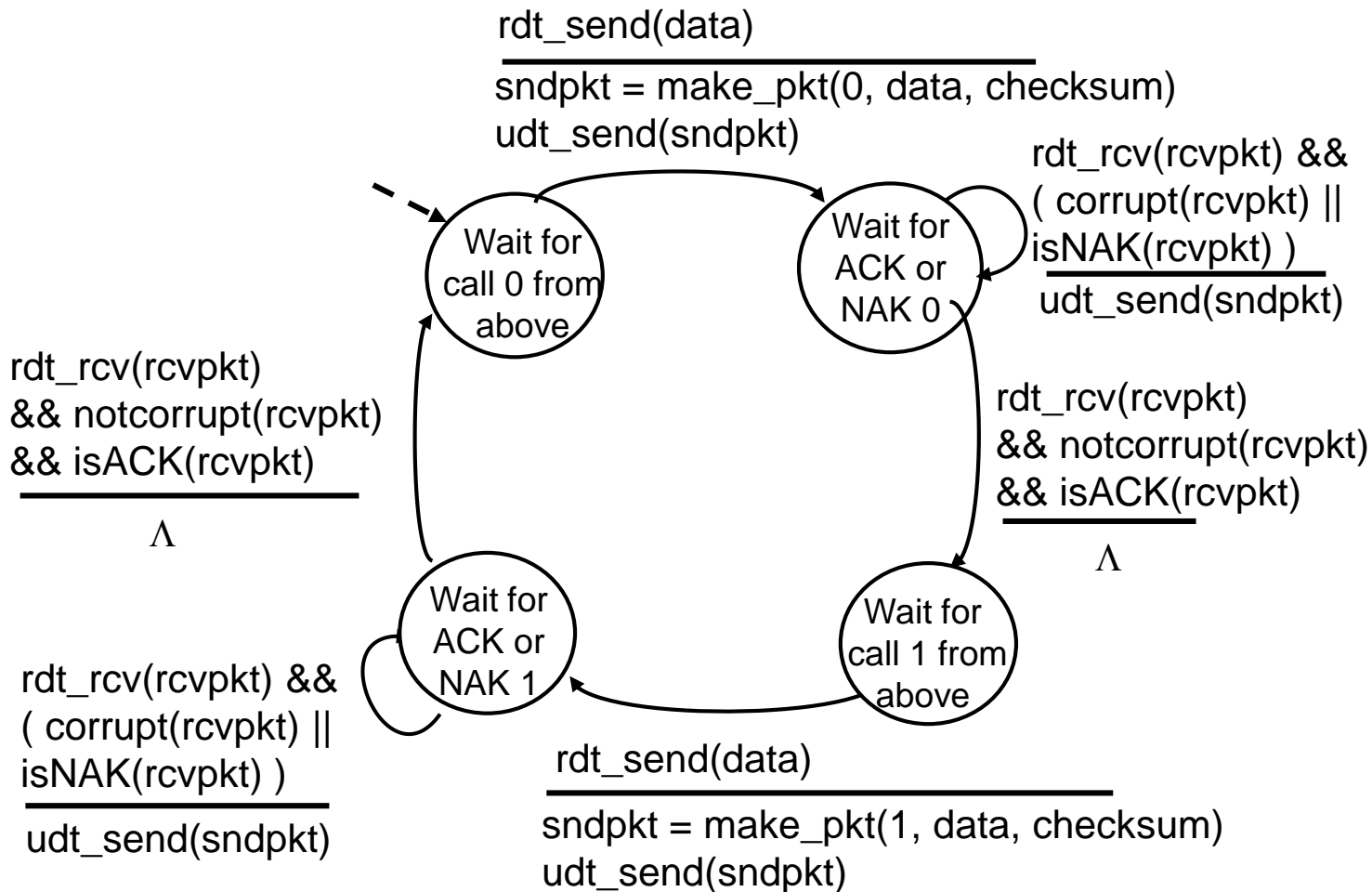

rdt2.1: receiver, handles garbled ACK/NAKs

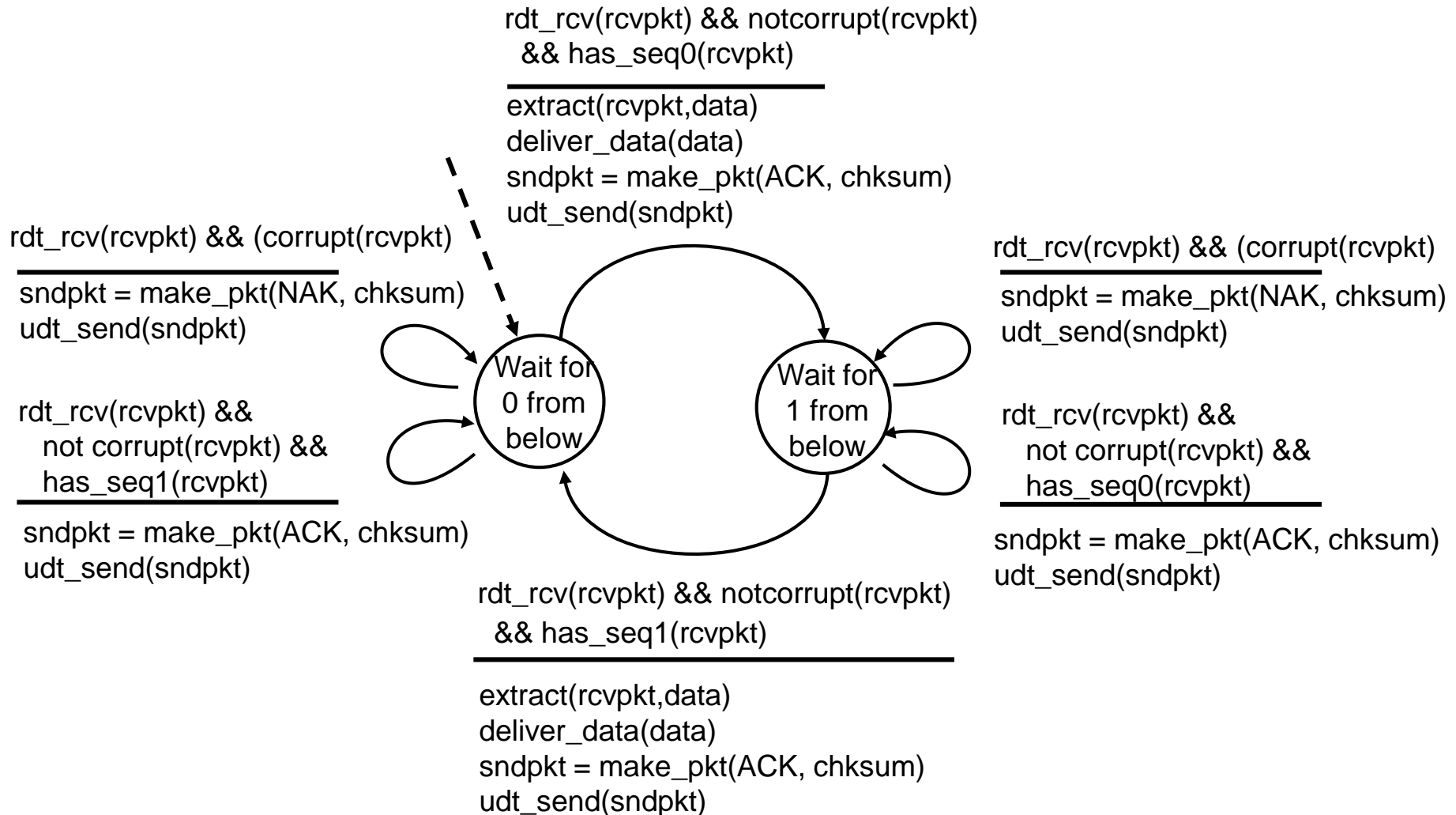

rdt2.1: discussion

sender:

- seq # added to pkt
- two seq. #'s (0,1) will suffice. Why?
- must check if received ACK/NAK corrupted
- twice as many states
 - state must “remember” whether “expected” pkt should have seq # of 0 or 1

receiver:

- must check if received packet is duplicate
 - state indicates whether 0 or 1 is expected pkt seq #
- note: receiver can *not* know if its last ACK/NAK received OK at sender

rdt2.2: a NAK-free protocol

- same functionality as rdt2.1, using ACKs only
- instead of NAK, receiver sends ACK for last pkt received OK
 - receiver must *explicitly* include seq # of pkt being ACKed
- duplicate ACK at sender results in same action as NAK: *retransmit current pkt*

rdt2.2: sender, receiver fragments

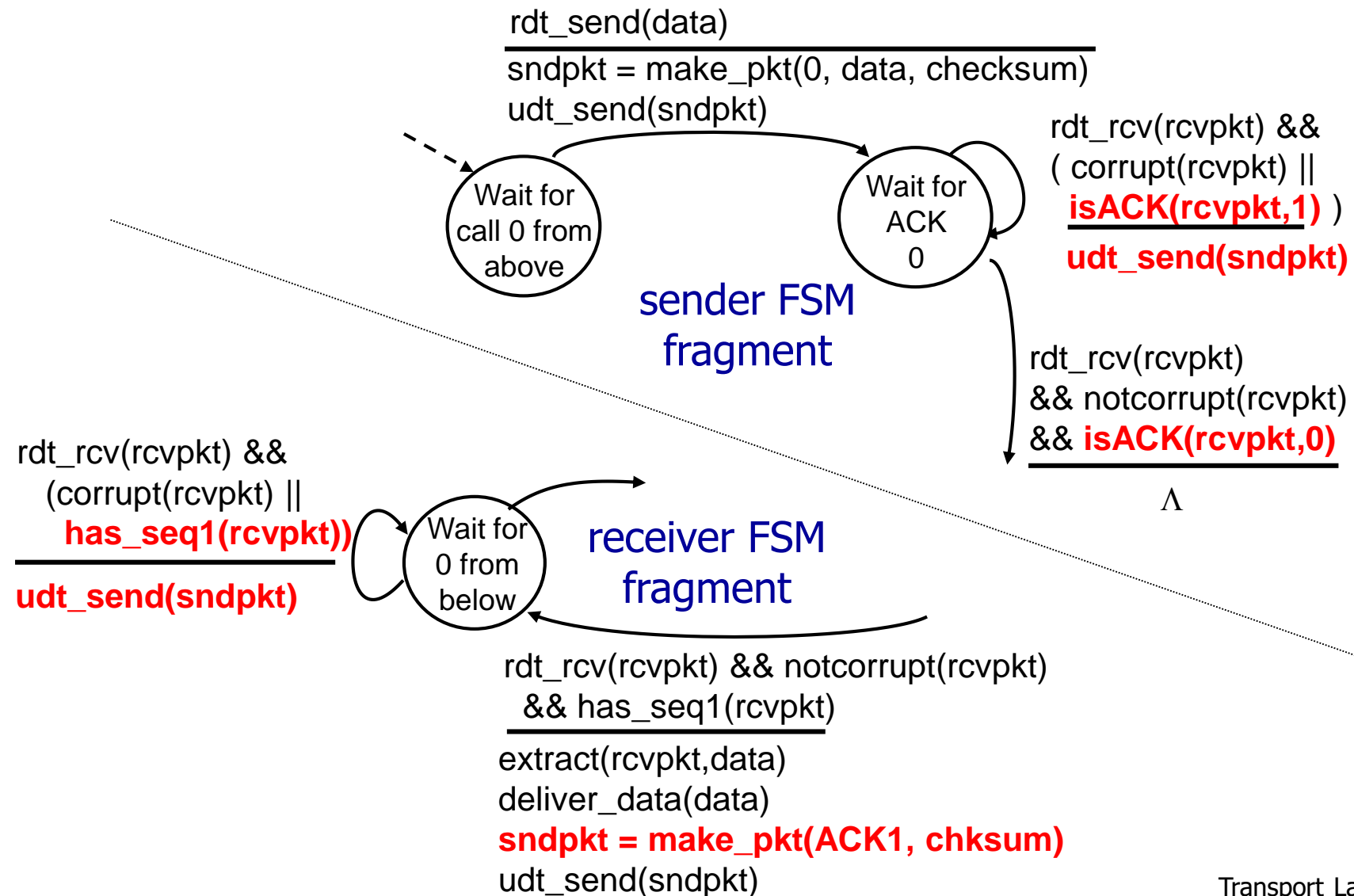

rdt3.0: channels with errors and loss

new assumption:

underlying channel can also lose packets (data, ACKs)

- checksum, seq. #, ACKs, retransmissions will be of help ... but not enough

approach: sender waits “reasonable” amount of time for ACK

- retransmits if no ACK received in this time
- if pkt (or ACK) just delayed (not lost):
 - retransmission will be duplicate, but seq. #'s already handles this
 - receiver must specify seq # of pkt being ACKed
- requires countdown timer

rdt3.0 sender

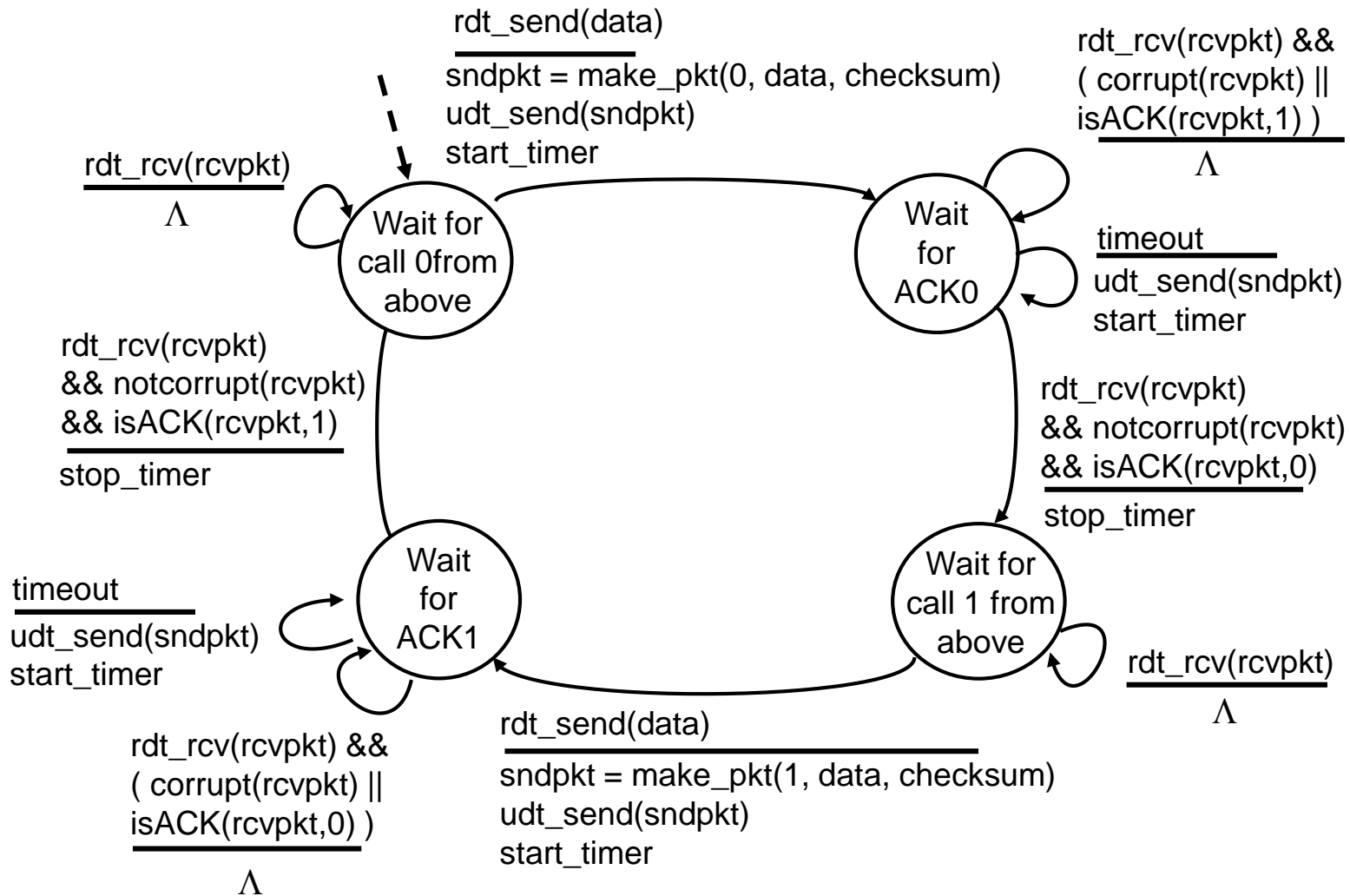

rdt3.0 in action

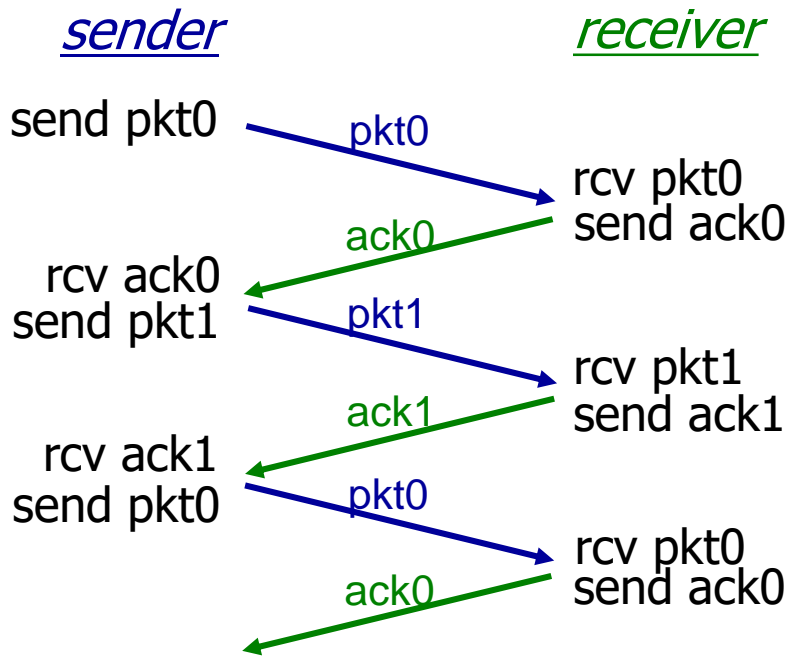

(a) no loss

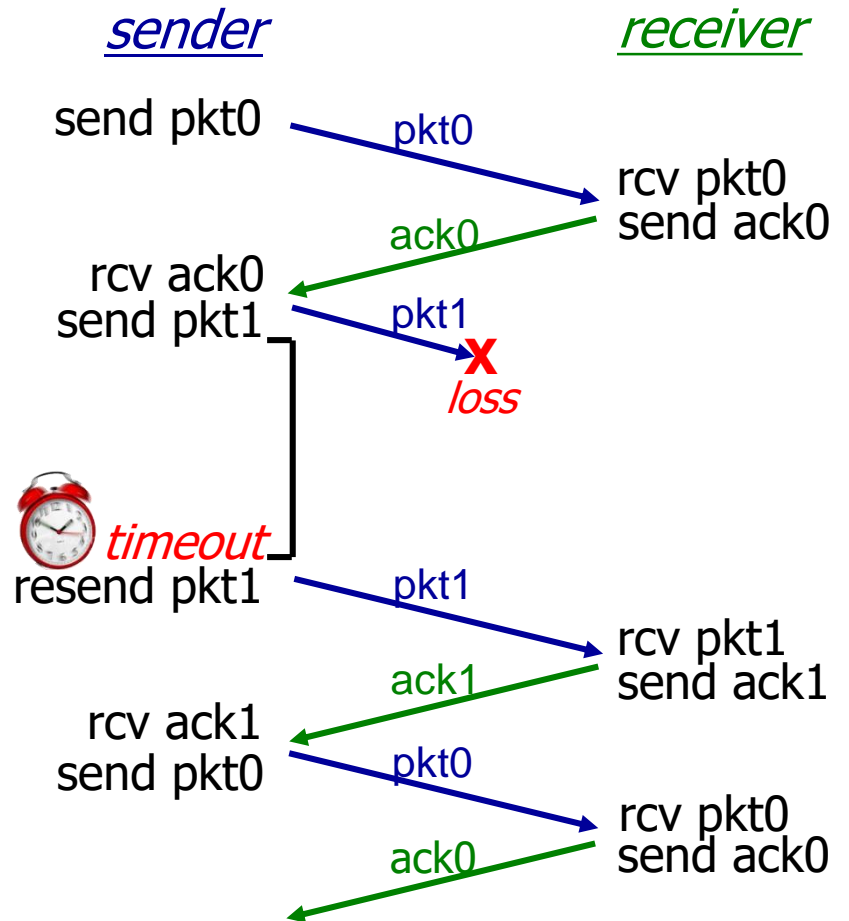

(b) packet loss

rdt3.0 in action

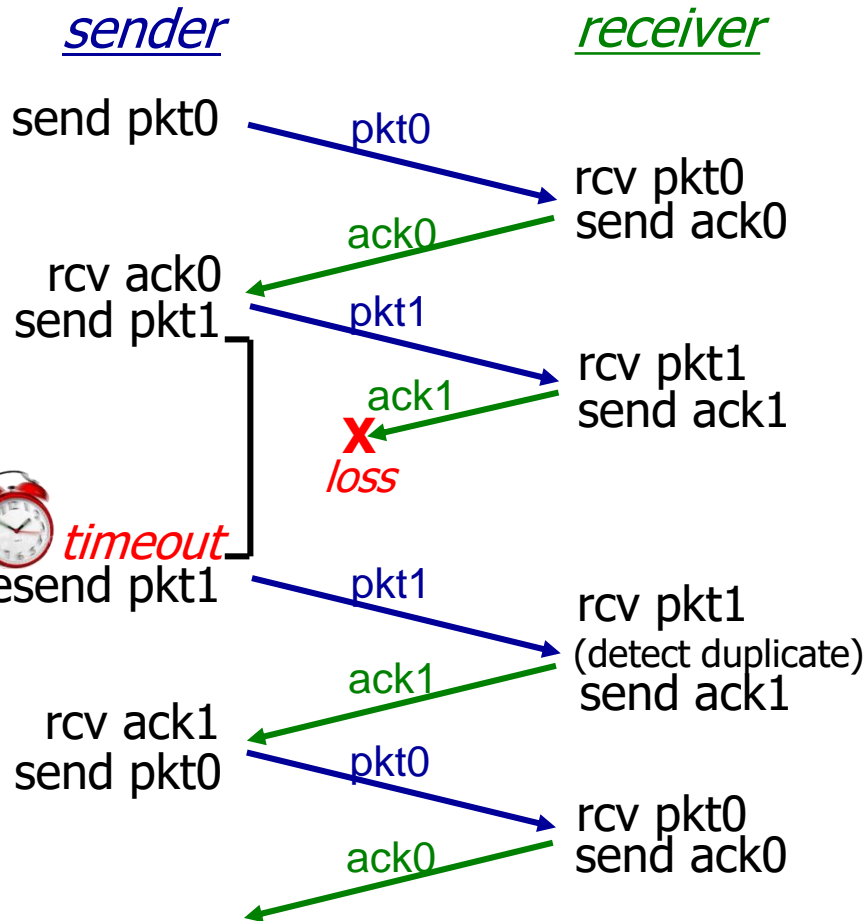

(c) ACK loss

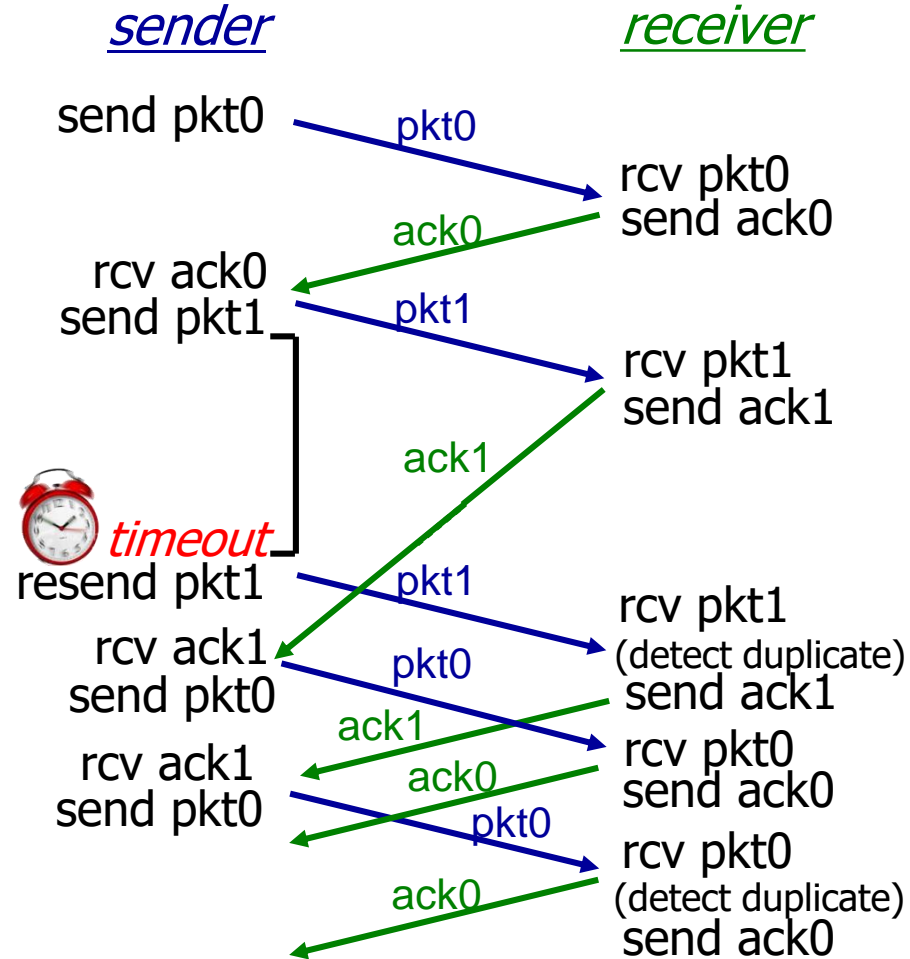

(d) premature timeout/ delayed ACK

Performance of rdt3.0

- rdt3.0 is correct, but performance stinks
- e.g.: 1 Gbps link, 15 ms prop. delay, 8000 bit packet:

$$D_{trans} = \frac{L}{R} = \frac{8000 \text{ bits}}{10^9 \text{ bits/sec}} = 8 \text{ microseconds}$$

- U_{sender} : *utilization* – fraction of time sender busy sending

$$U_{sender} = \frac{L/R}{RTT + L/R} = \frac{.008}{30.008} = 0.00027$$

- if RTT=30 msec, 1KB pkt every 30 msec: 33kB/sec thruput over 1 Gbps link
- network protocol limits use of physical resources!

rdt3.0: stop-and-wait operation

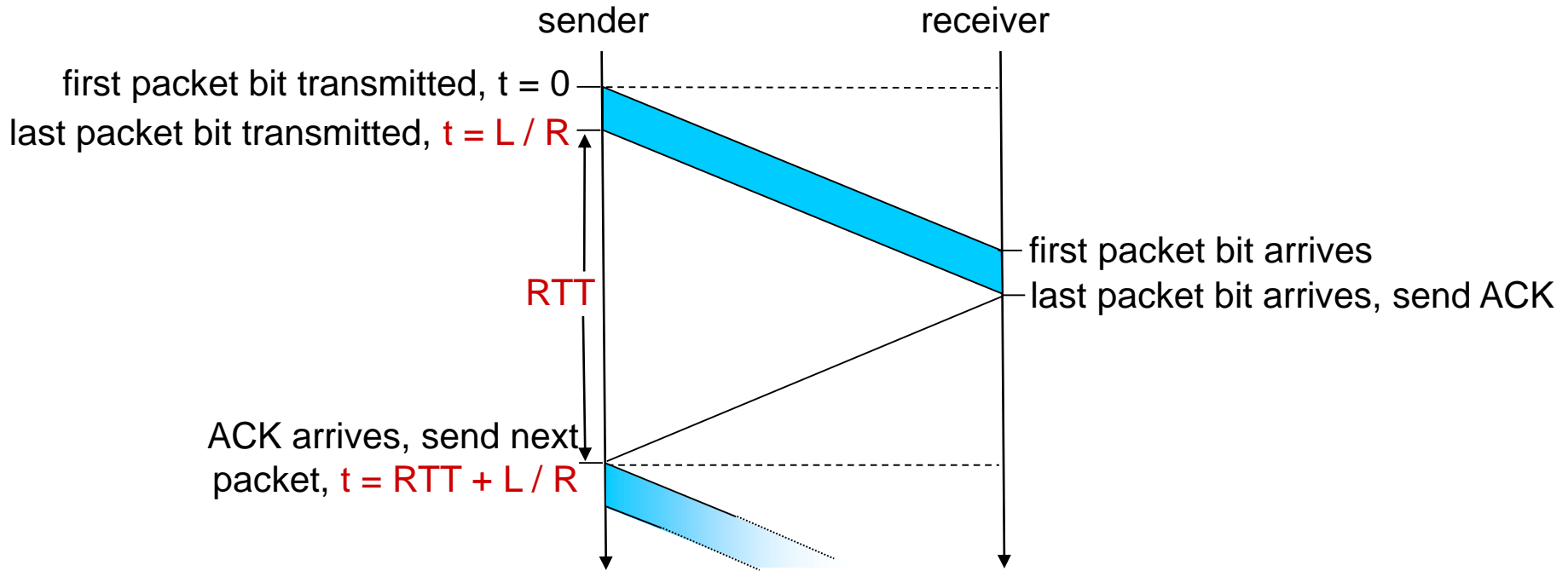

$$U_{\text{sender}} = \frac{L/R}{RTT + L/R} = \frac{.008}{30.008} = 0.00027$$

Pipelined protocols

pipelining: sender allows multiple, “in-flight”, yet-to-be-acknowledged pkts

- range of sequence numbers must be increased
- buffering at sender and/or receiver

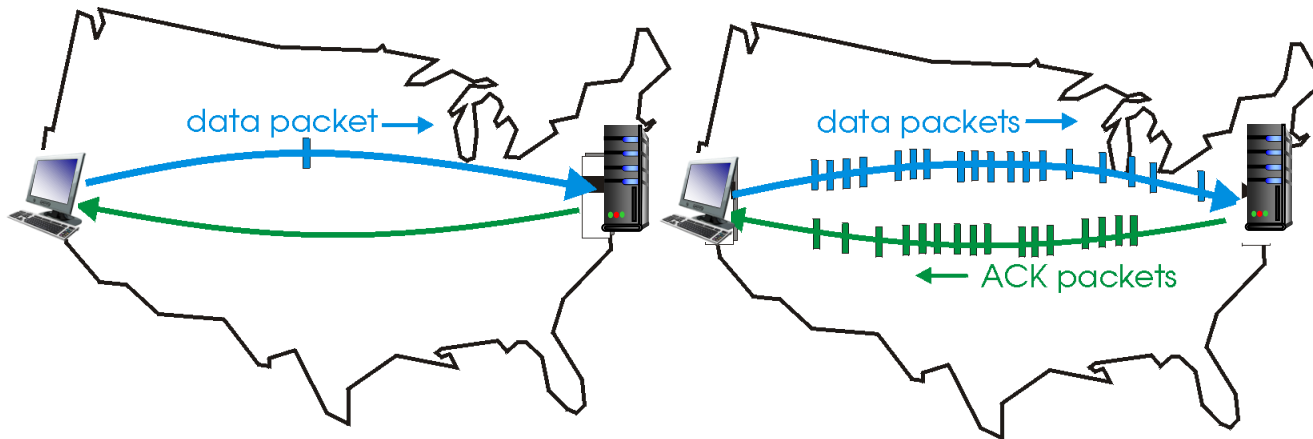

(a) a stop-and-wait protocol in operation

(b) a pipelined protocol in operation

- two generic forms of pipelined protocols: *go-Back-N*, *selective repeat*

Pipelining: increased utilization

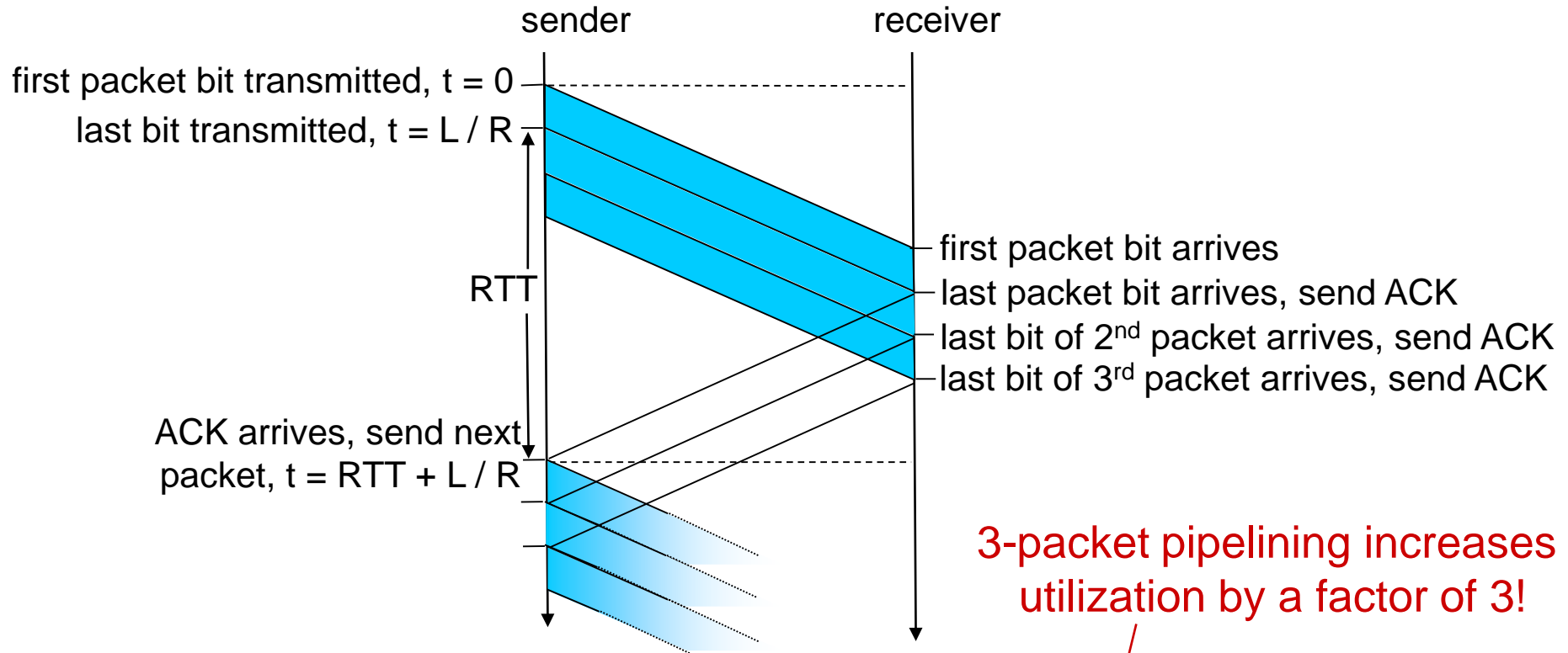

3-packet pipelining increases utilization by a factor of 3!

$$U_{sender} = \frac{3L / R}{RTT + L / R} = \frac{.024}{30.008} = 0.00081$$

Pipelined protocols: overview

Go-back-N:

- sender can have up to N unacked packets in pipeline
- receiver only sends *cumulative ack*
 - doesn't ack packet if there's a gap
- sender has timer for oldest unacked packet
 - when timer expires, retransmit *all* unacked packets

Selective Repeat:

- sender can have up to N unack'ed packets in pipeline
- rcvr sends *individual ack* for each packet
- sender maintains timer for each unacked packet
 - when timer expires, retransmit only that unacked packet

Go-Back-N: sender

- k-bit seq # in pkt header
- “window” of up to N, consecutive unack’ed pkts allowed

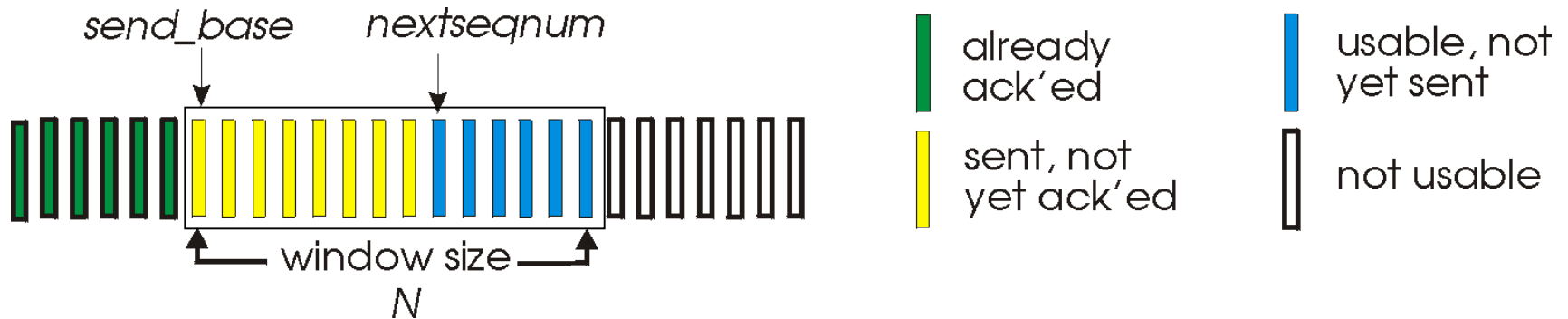

- ACK(n): ACKs all pkts up to, including seq # n - “*cumulative ACK*”
 - may receive duplicate ACKs (see receiver)
- timer for oldest in-flight pkt
- *timeout(n)*: retransmit packet n and all higher seq # pkts in window

GBN: sender extended FSM

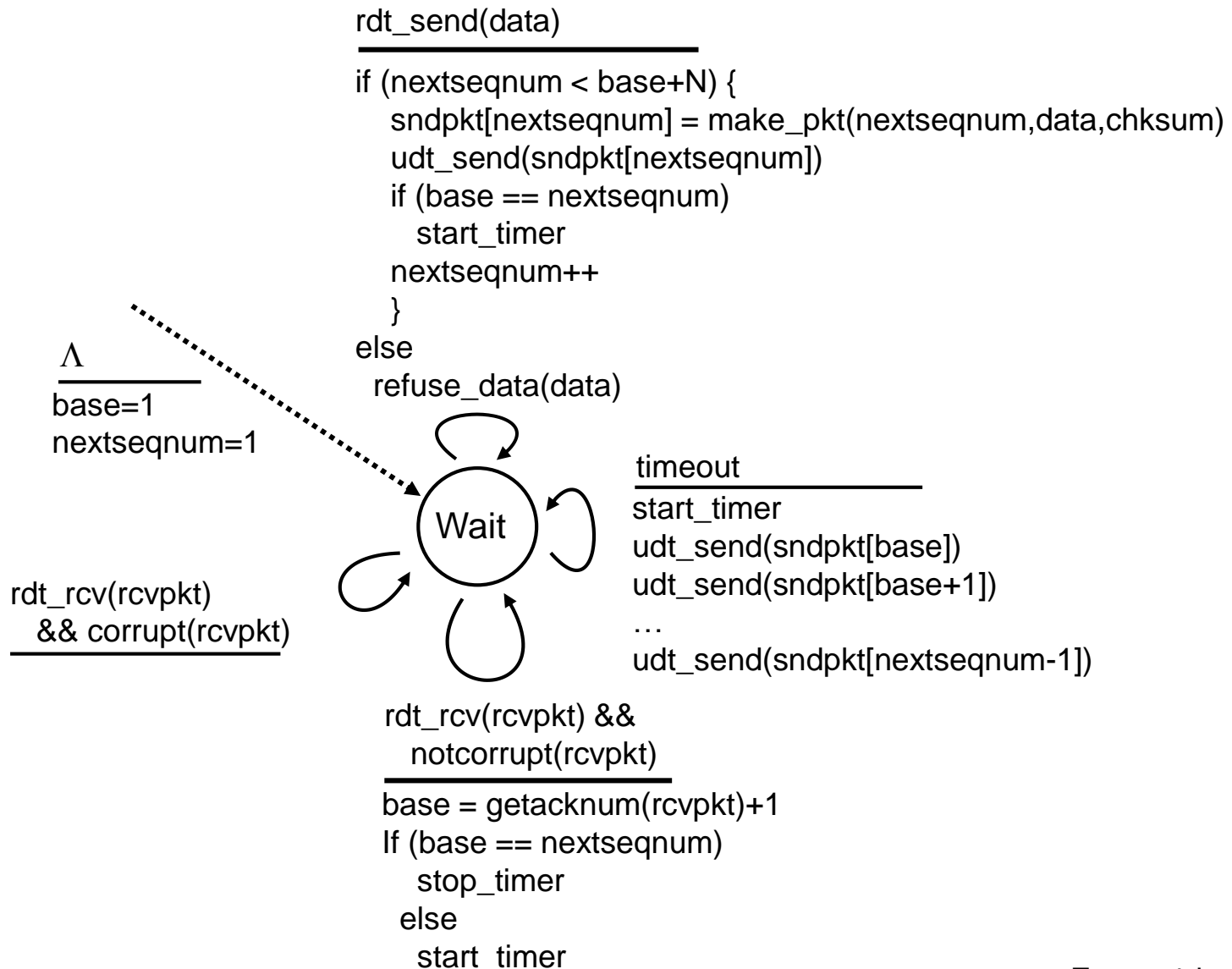

GBN: receiver extended FSM

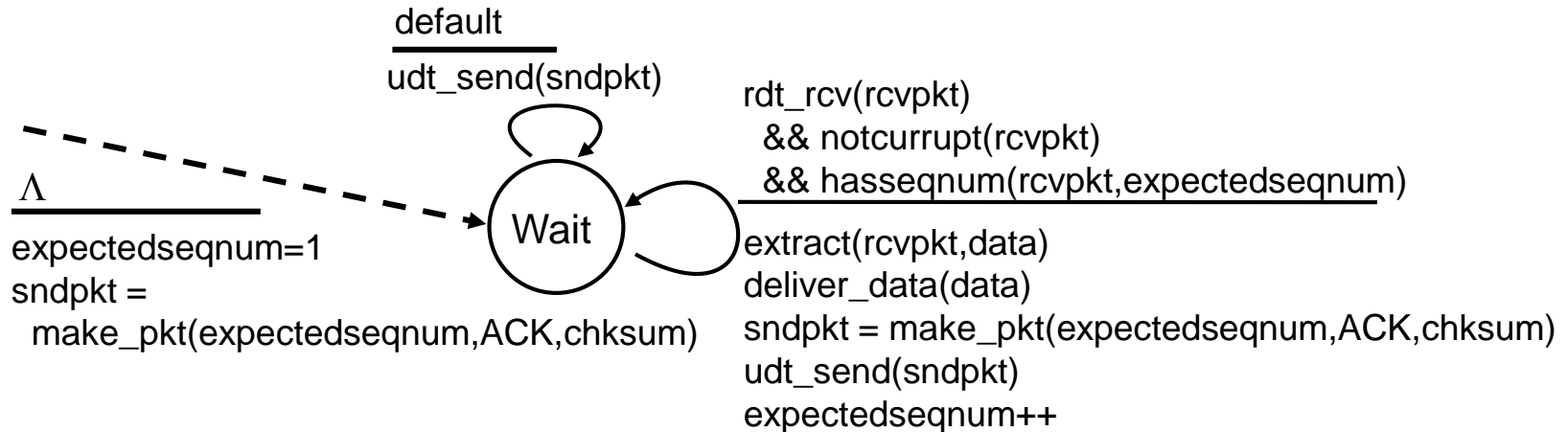

ACK-only: always send ACK for correctly-received pkt with highest *in-order* seq #

- may generate duplicate ACKs
- need only remember **expectedseqnum**
- out-of-order pkt:
 - discard (don't buffer): *no receiver buffering!*
 - re-ACK pkt with highest in-order seq #

GBN in action

sender window (N=4)

0 1 2 3 4 5 6 7 8
 0 1 2 3 4 5 6 7 8
 0 1 2 3 4 5 6 7 8
 0 1 2 3 4 5 6 7 8

0 1 2 3 4 5 6 7 8
 0 1 2 3 4 5 6 7 8

0 1 2 3 4 5 6 7 8
 0 1 2 3 4 5 6 7 8
 0 1 2 3 4 5 6 7 8
 0 1 2 3 4 5 6 7 8

sender

send pkt0
 send pkt1
 send pkt2
 send pkt3
 (wait)

rcv ack0, send pkt4
 rcv ack1, send pkt5

ignore duplicate ACK



pkt 2 timeout

send pkt2
 send pkt3
 send pkt4
 send pkt5

receiver

receive pkt0, send ack0
 receive pkt1, send ack1

receive pkt3, discard,
 (re)send ack1

receive pkt4, discard,
 (re)send ack1

receive pkt5, discard,
 (re)send ack1

rcv pkt2, deliver, send ack2
 rcv pkt3, deliver, send ack3
 rcv pkt4, deliver, send ack4
 rcv pkt5, deliver, send ack5

X loss

Selective repeat

- receiver *individually* acknowledges all correctly received pkts
 - buffers pkts, as needed, for eventual in-order delivery to upper layer
- sender only resends pkts for which ACK not received
 - sender timer for each unACKed pkt
- sender window
 - N consecutive seq #'s
 - limits seq #'s of sent, unACKed pkts

Selective repeat: sender, receiver windows

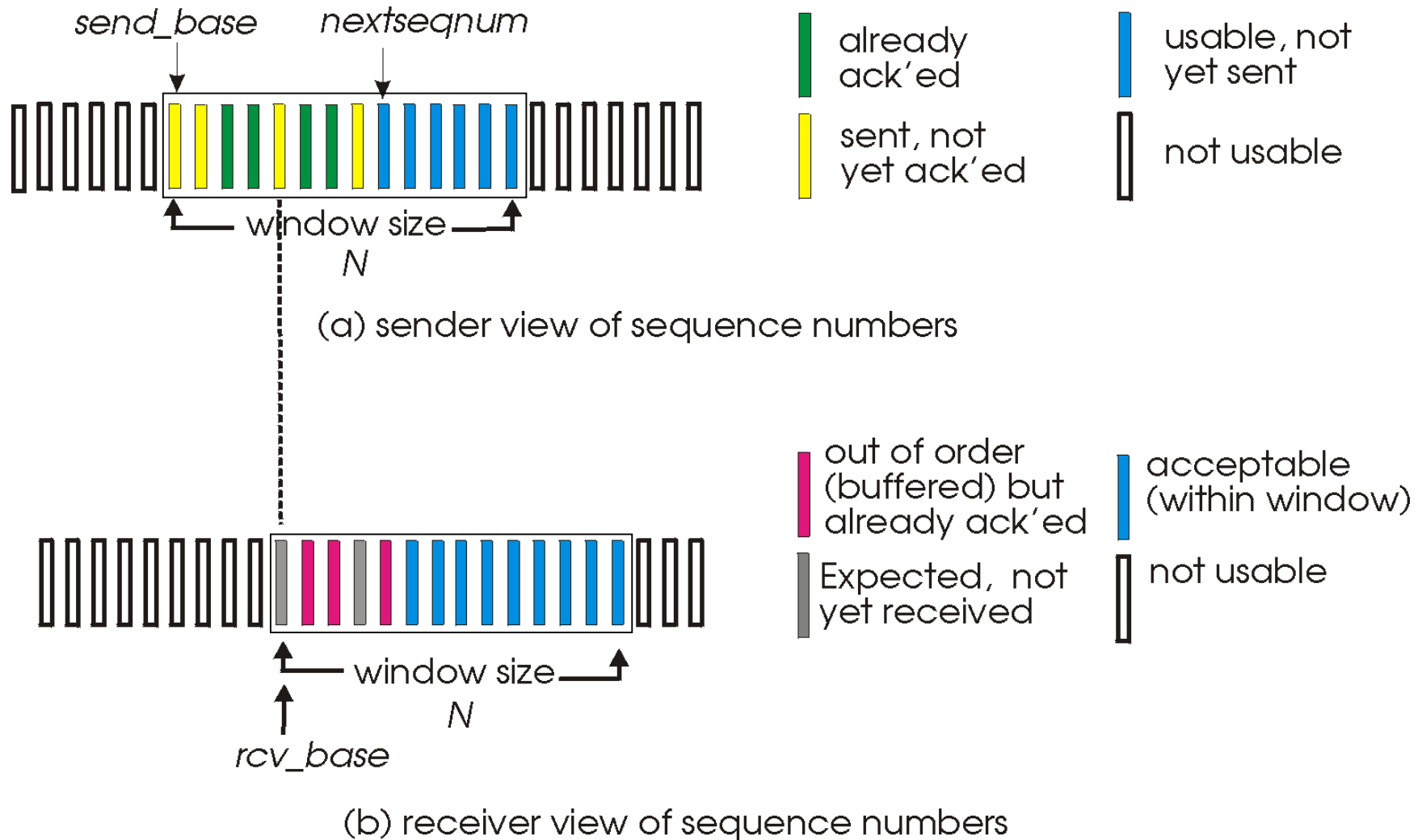

Selective repeat

sender

data from above:

- if next available seq # in window, send pkt

timeout(n):

- resend pkt n, restart timer

ACK(n) in [sendbase,sendbase+N]:

- mark pkt n as received
- if n smallest unACKed pkt, advance window base to next unACKed seq #

receiver

pkt n in [rcvbase,rcvbase+N-1]

- send ACK(n)
- out-of-order: buffer
- in-order: deliver (also deliver buffered, in-order pkts), advance window to next not-yet-received pkt

pkt n in [rcvbase-N,rcvbase-1]

- ACK(n)

otherwise:

- ignore

Selective repeat in action

sender window (N=4)

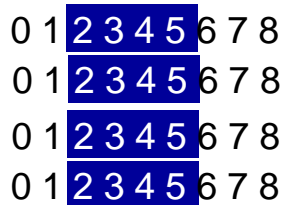
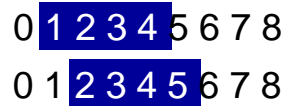
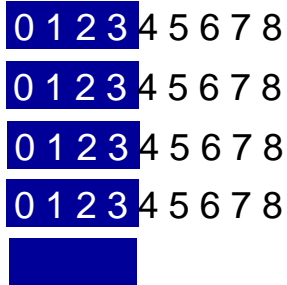

sender

send pkt0
 send pkt1
 send pkt2
 send pkt3
 (wait)

rcv ack0, send pkt4
 rcv ack1, send pkt5

record ack3 arrived



pkt 2 timeout

send pkt2
 record ack4 arrived
 record ack5 arrived

receiver

receive pkt0, send ack0
 receive pkt1, send ack1

receive pkt3, buffer,
 send ack3

receive pkt4, buffer,
 send ack4

receive pkt5, buffer,
 send ack5

rcv pkt2; deliver pkt2,
 pkt3, pkt4, pkt5; send ack2

Q: what happens when ack2 arrives?

Selective repeat: dilemma

example:

- seq #'s: 0, 1, 2, 3
- window size=3
- receiver sees no difference in two scenarios!
- duplicate data accepted as new in (b)

Q: what relationship between seq # size and window size to avoid problem in (b)?

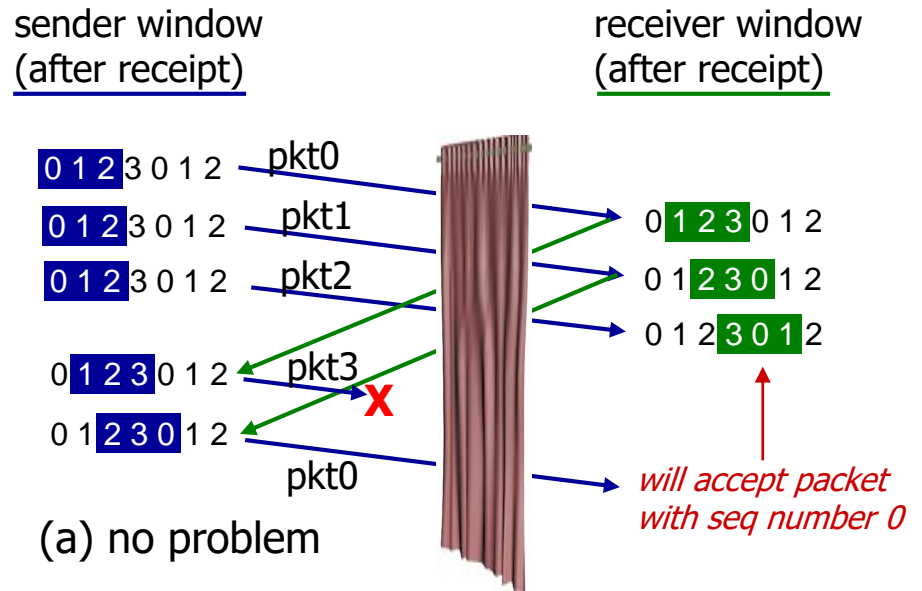

receiver can't see sender side.
receiver behavior identical in both cases!
something's (very) wrong!

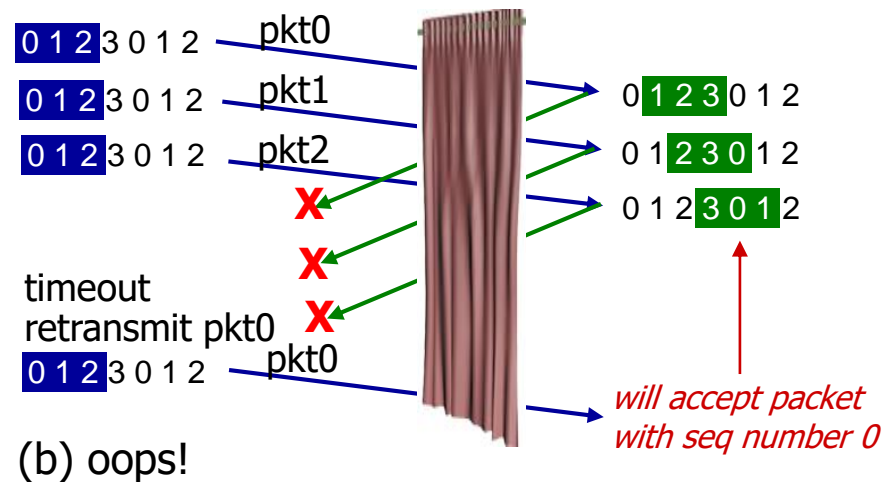

Chapter 3 outline

3.1 transport-layer services

3.2 multiplexing and demultiplexing

3.3 connectionless transport: UDP

3.4 principles of reliable data transfer

3.5 connection-oriented transport: TCP

- segment structure
- reliable data transfer
- flow control
- connection management

3.6 principles of congestion control

3.7 TCP congestion control

TCP: Overview

RFCs: 793, 1122, 1323, 2018, 2581

- **point-to-point:**
 - one sender, one receiver
- **reliable, in-order *byte stream*:**
 - no “message boundaries”
- **pipelined:**
 - TCP congestion and flow control set window size
- **full duplex data:**
 - bi-directional data flow in same connection
 - MSS: maximum segment size
- **connection-oriented:**
 - handshaking (exchange of control msgs) initializes sender, receiver state before data exchange
- **flow controlled:**
 - sender will not overwhelm receiver

TCP segment structure

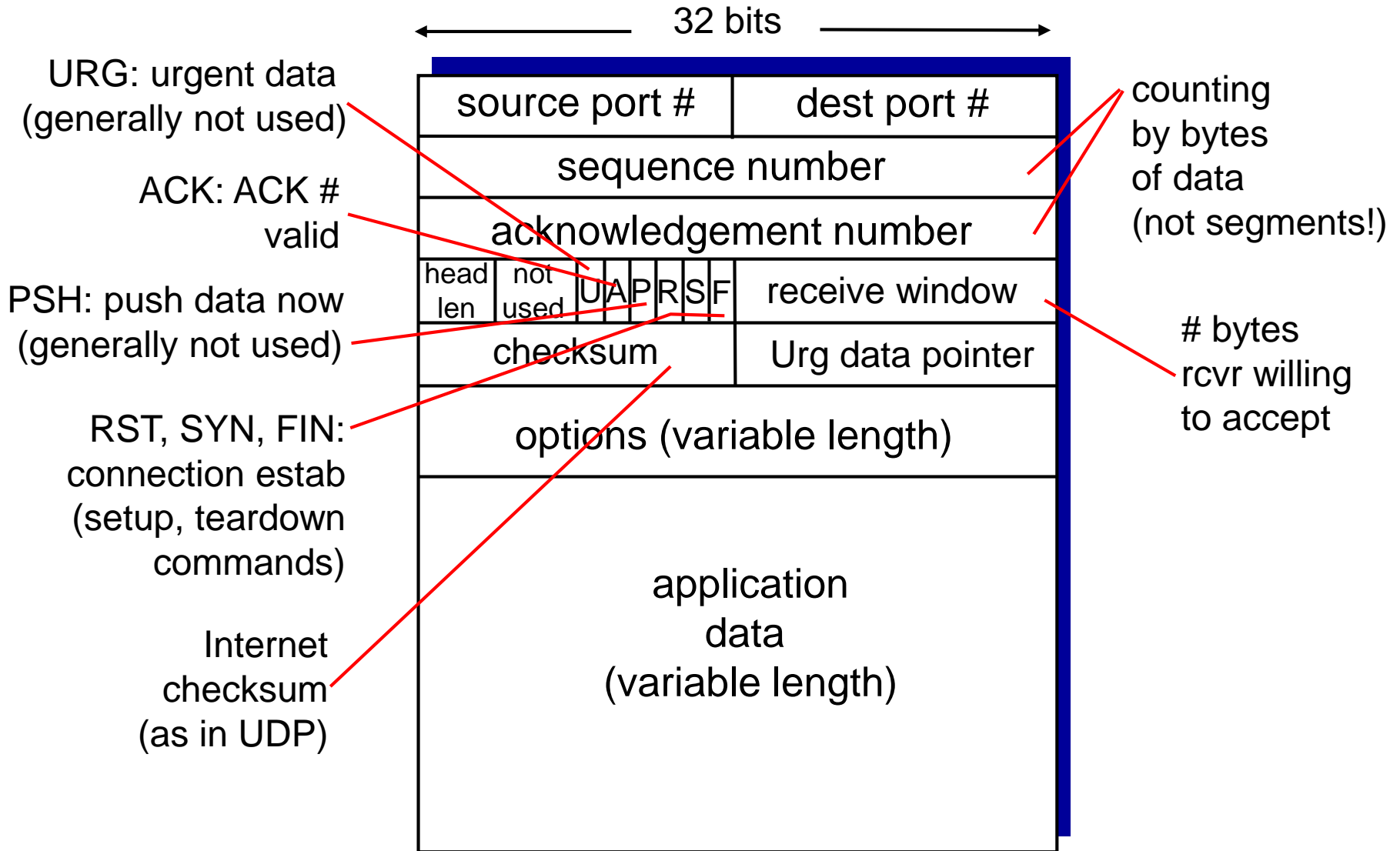

TCP seq. numbers, ACKs

sequence numbers:

- byte stream “number” of first byte in segment’s data

acknowledgements:

- seq # of next byte expected from other side
- cumulative ACK

Q: how receiver handles out-of-order segments

- **A:** TCP spec doesn’t say, - up to implementor

outgoing segment from sender

source port #	dest port #
sequence number	
acknowledgement number	
	rwnd
checksum	urg pointer

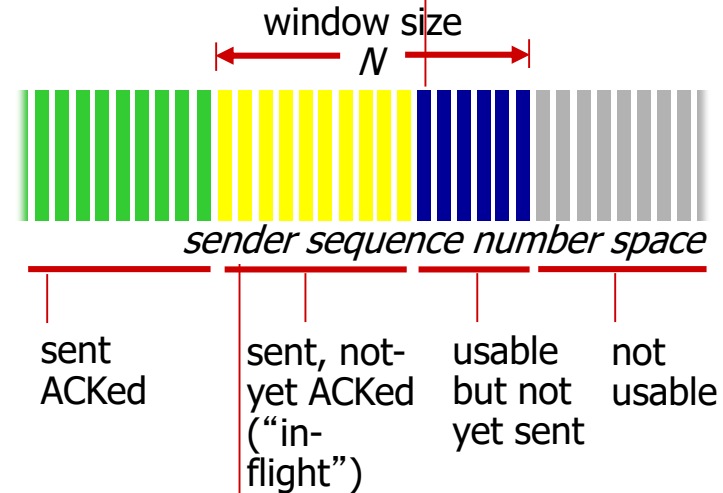

incoming segment to sender

source port #	dest port #
sequence number	
acknowledgement number	
	A
checksum	urg pointer

TCP seq. numbers, ACKs

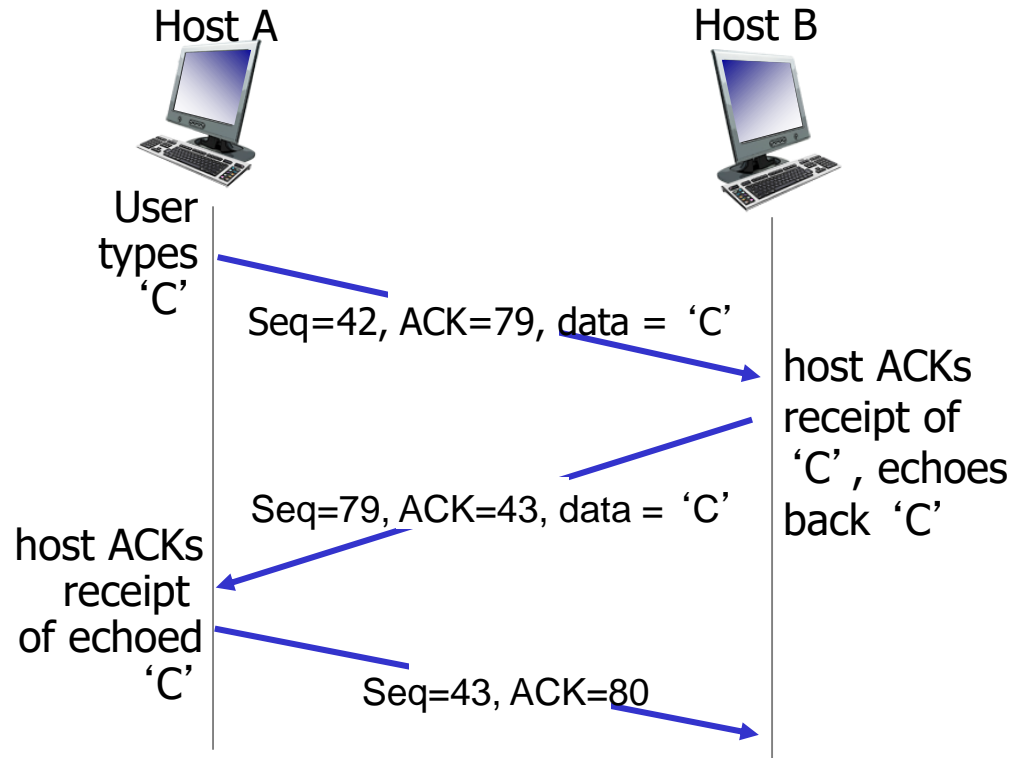

simple telnet scenario

TCP round trip time, timeout

Q: how to set TCP timeout value?

- longer than RTT
 - but RTT varies
- *too short*: premature timeout, unnecessary retransmissions
- *too long*: slow reaction to segment loss

Q: how to estimate RTT?

- **SampleRTT**: measured time from segment transmission until ACK receipt
 - ignore retransmissions
- **SampleRTT** will vary, want estimated RTT “smoother”
 - average several *recent* measurements, not just current **SampleRTT**

TCP round trip time, timeout

$$\text{EstimatedRTT} = (1 - \alpha) * \text{EstimatedRTT} + \alpha * \text{SampleRTT}$$

- exponential weighted moving average
- influence of past sample decreases exponentially fast
- typical value: $\alpha = 0.125$

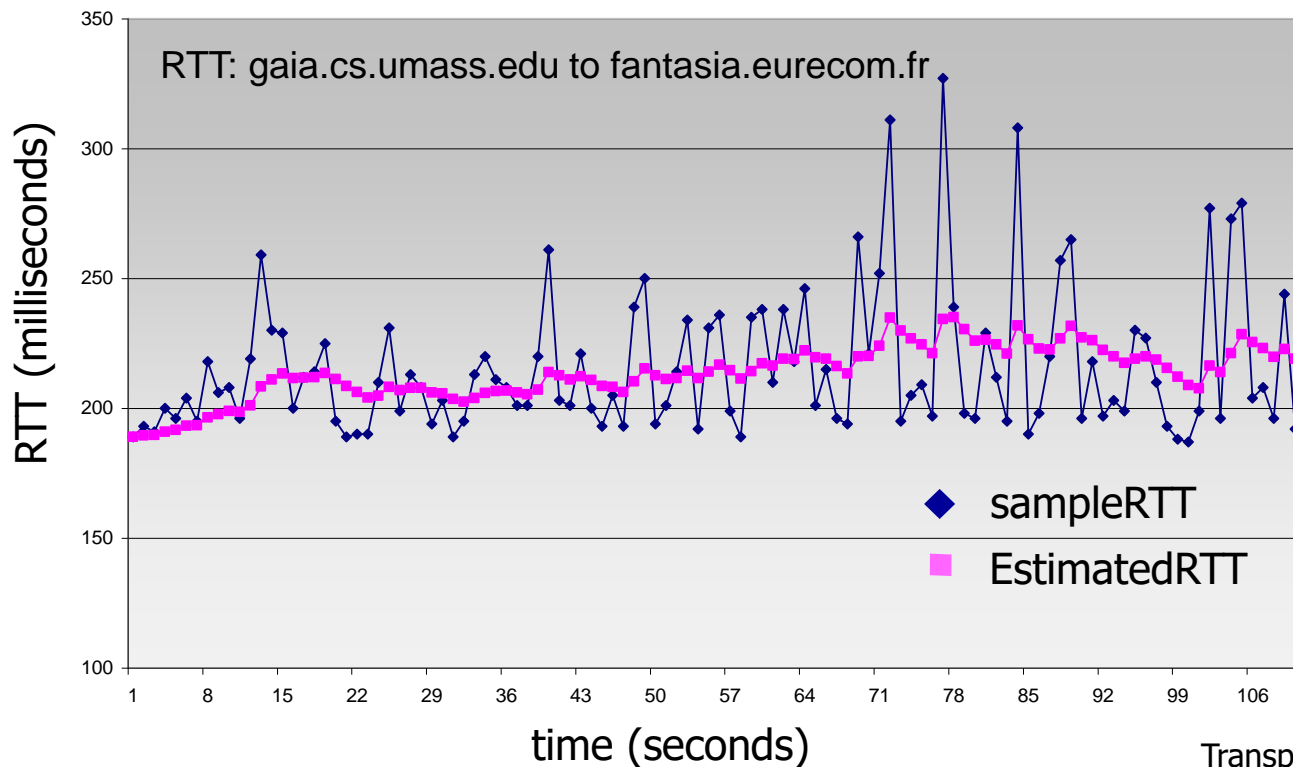

TCP round trip time, timeout

- **timeout interval:** **EstimatedRTT** plus “safety margin”
 - large variation in **EstimatedRTT** → larger safety margin
- estimate **SampleRTT** deviation from **EstimatedRTT**:

$$\text{DevRTT} = (1-\beta) * \text{DevRTT} + \beta * |\text{SampleRTT} - \text{EstimatedRTT}|$$

(typically, $\beta = 0.25$)

$$\text{TimeoutInterval} = \text{EstimatedRTT} + 4 * \text{DevRTT}$$



↑
estimated RTT

↑
“safety margin”

Chapter 3 outline

3.1 transport-layer services

3.2 multiplexing and demultiplexing

3.3 connectionless transport: UDP

3.4 principles of reliable data transfer

3.5 connection-oriented transport: TCP

- segment structure
- reliable data transfer
- flow control
- connection management

3.6 principles of congestion control

3.7 TCP congestion control

TCP reliable data transfer

- TCP creates rdt service on top of IP' s unreliable service
 - pipelined segments
 - cumulative acks
 - single retransmission timer
- retransmissions triggered by:
 - timeout events
 - duplicate acks

let' s initially consider simplified TCP sender:

- ignore duplicate acks
- ignore flow control, congestion control

TCP sender events:

data rcvd from app:

- create segment with seq #
- seq # is byte-stream number of first data byte in segment
- start timer if not already running
 - think of timer as for oldest unacked segment
 - expiration interval: `TimeoutInterval`

timeout:

- retransmit segment that caused timeout
- restart timer

ack rcvd:

- if ack acknowledges previously unacked segments
 - update what is known to be ACKed
 - start timer if there are still unacked segments

TCP sender (simplified)

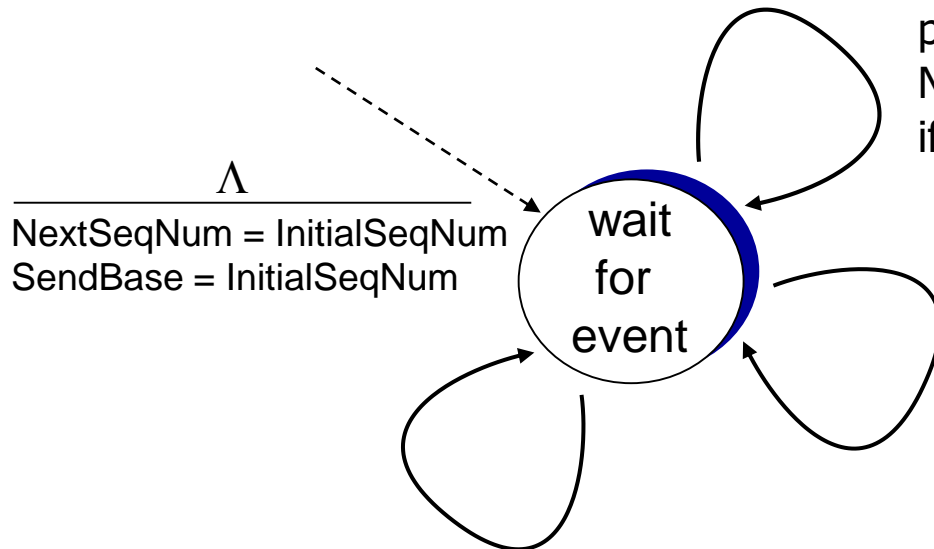

Λ
NextSeqNum = InitialSeqNum
SendBase = InitialSeqNum

data received from application above
create segment, seq. #: NextSeqNum
pass segment to IP (i.e., "send")
NextSeqNum = NextSeqNum + length(data)
if (timer currently not running)
start timer

timeout
retransmit not-yet-acked segment
with smallest seq. #
start timer

ACK received, with ACK field value y

```
if (y > SendBase) {  
    SendBase = y  
    /* SendBase-1: last cumulatively ACKed byte */  
    if (there are currently not-yet-acked segments)  
        start timer  
    else stop timer  
}
```

TCP: retransmission scenarios

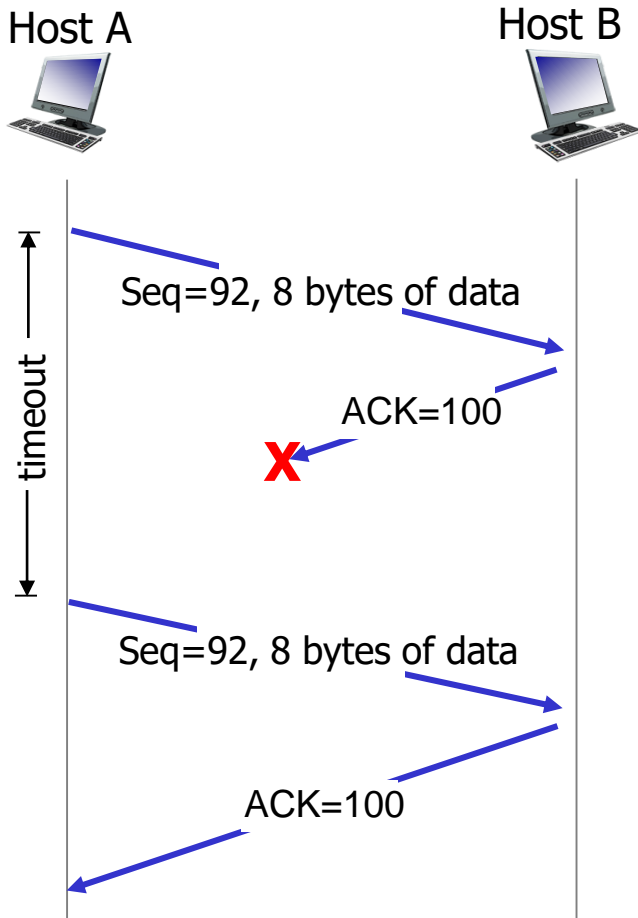

lost ACK scenario

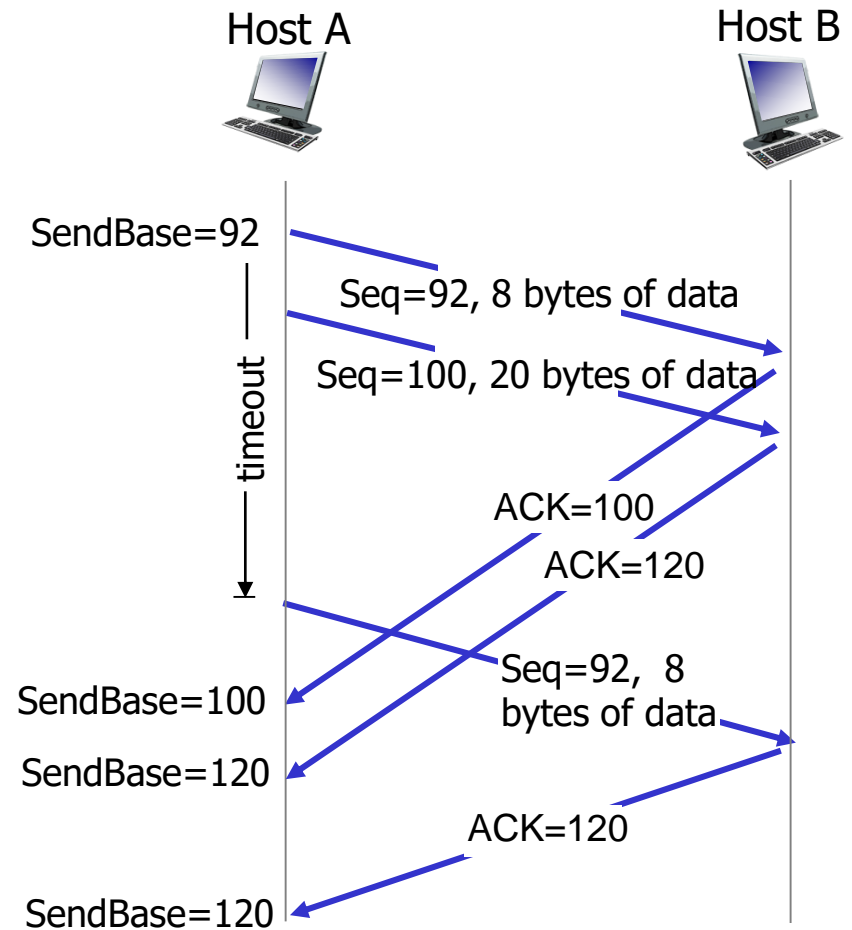

premature timeout

TCP: retransmission scenarios

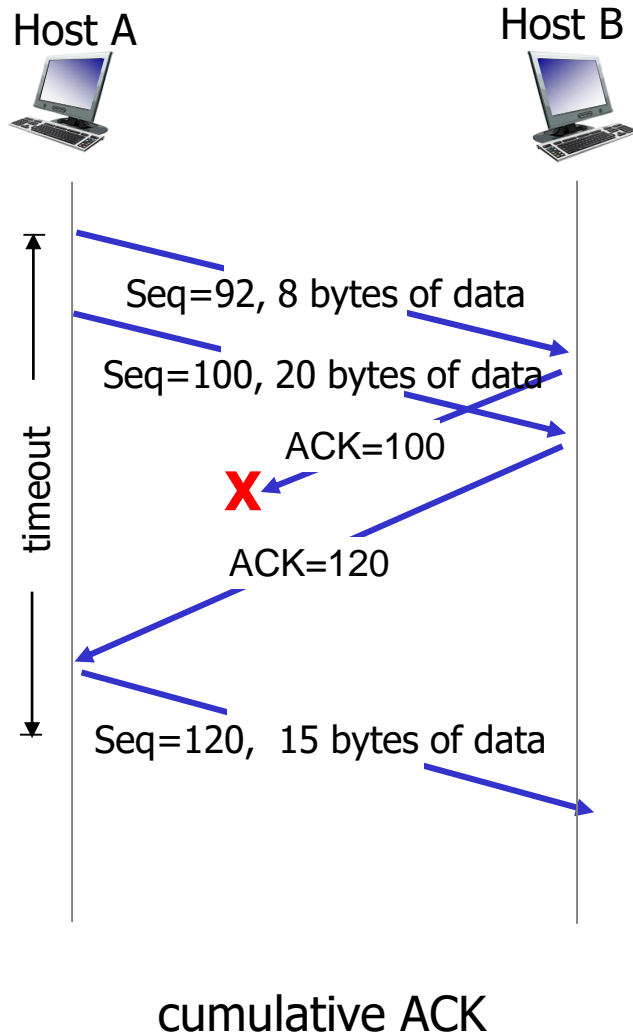

TCP ACK generation [RFC 1122, RFC 2581]

<i>event at receiver</i>	<i>TCP receiver action</i>
arrival of in-order segment with expected seq #. All data up to expected seq # already ACKed	delayed ACK. Wait up to 500ms for next segment. If no next segment, send ACK
arrival of in-order segment with expected seq #. One other segment has ACK pending	immediately send single cumulative ACK, ACKing both in-order segments
arrival of out-of-order segment higher-than-expected seq. # . Gap detected	immediately send <i>duplicate ACK</i> , indicating seq. # of next expected byte
arrival of segment that partially or completely fills gap	immediate send ACK, provided that segment starts at lower end of gap

TCP fast retransmit

- time-out period often relatively long:
 - long delay before resending lost packet
- detect lost segments via duplicate ACKs.
 - sender often sends many segments back-to-back
 - if segment is lost, there will likely be many duplicate ACKs.

TCP fast retransmit

- if sender receives 3 ACKs for same data (“triple duplicate ACKs”), resend unacked segment with smallest seq #
- likely that unacked segment lost, so don't wait for timeout

TCP fast retransmit

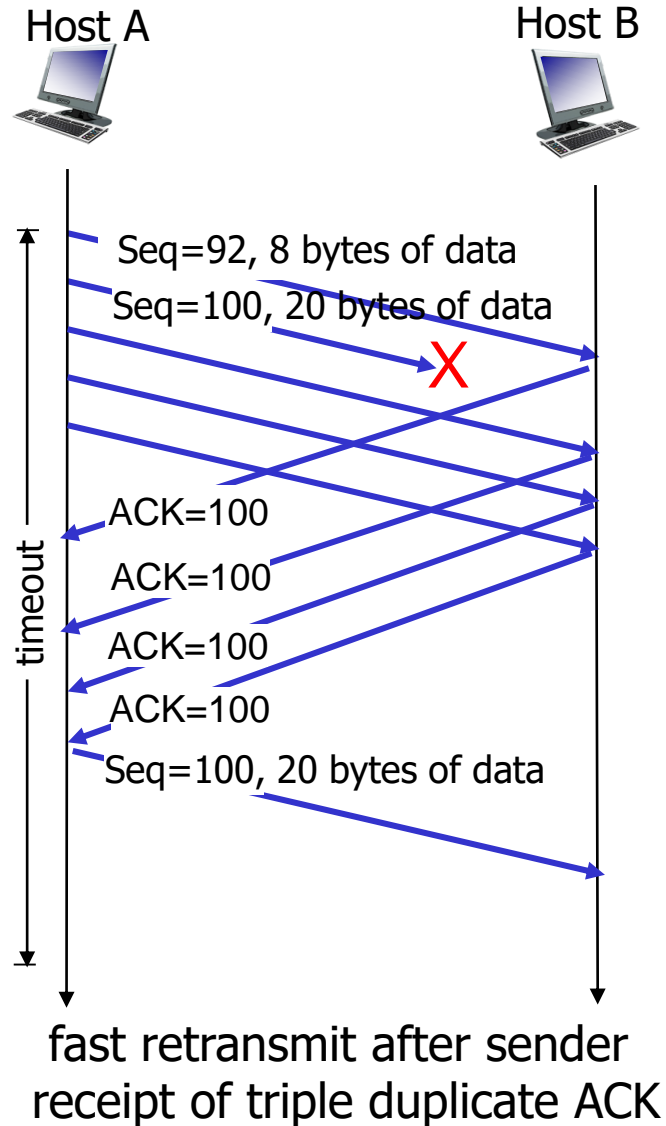

Chapter 3 outline

3.1 transport-layer services

3.2 multiplexing and demultiplexing

3.3 connectionless transport: UDP

3.4 principles of reliable data transfer

3.5 connection-oriented transport: TCP

- segment structure
- reliable data transfer
- flow control
- connection management

3.6 principles of congestion control

3.7 TCP congestion control

TCP flow control

application may remove data from TCP socket buffers

... slower than TCP receiver is delivering (sender is sending)

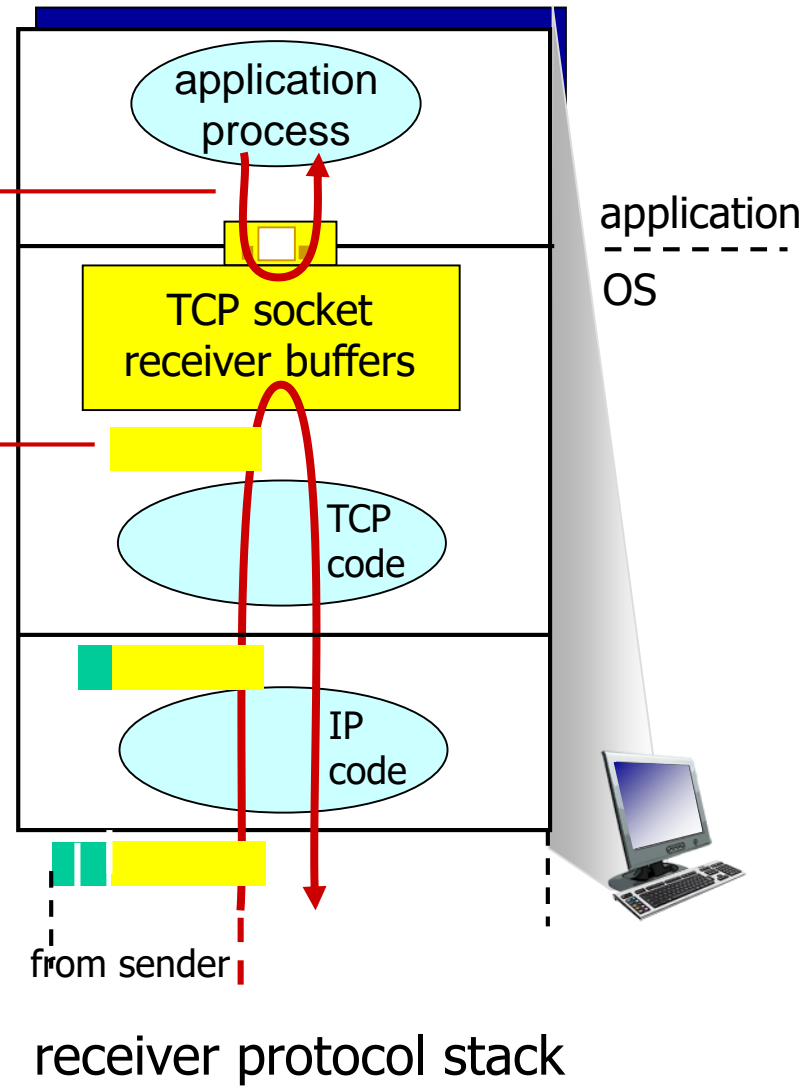

flow control

receiver controls sender, so sender won't overflow receiver's buffer by transmitting too much, too fast

TCP flow control

- receiver “advertises” free buffer space by including **rwnd** value in TCP header of receiver-to-sender segments
 - **RcvBuffer** size set via socket options (typical default is 4096 bytes)
 - many operating systems autoadjust **RcvBuffer**
- sender limits amount of unacked (“in-flight”) data to receiver’s **rwnd** value
- guarantees receive buffer will not overflow

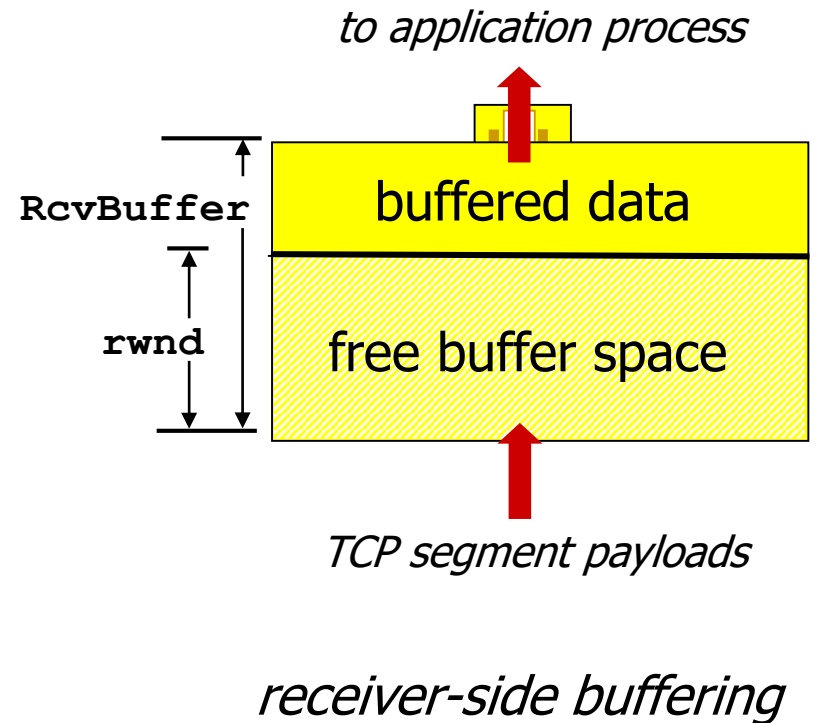

Chapter 3 outline

3.1 transport-layer services

3.2 multiplexing and demultiplexing

3.3 connectionless transport: UDP

3.4 principles of reliable data transfer

3.5 connection-oriented transport: TCP

- segment structure
- reliable data transfer
- flow control
- connection management

3.6 principles of congestion control

3.7 TCP congestion control

Connection Management

before exchanging data, sender/receiver “handshake”:

- agree to establish connection (each knowing the other willing to establish connection)
- agree on connection parameters

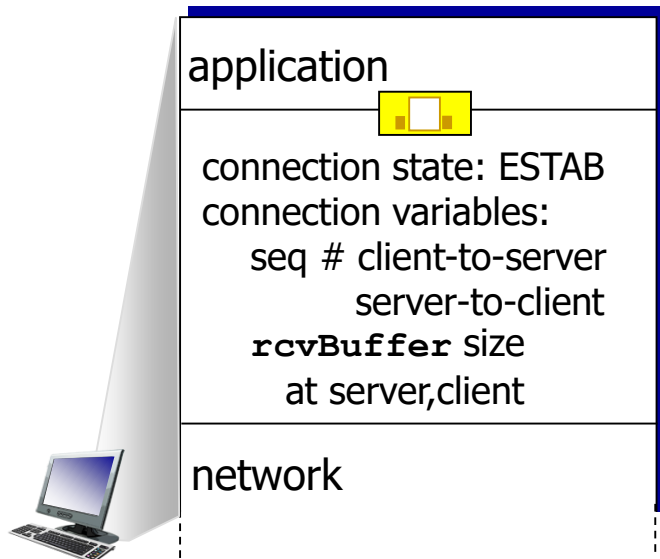

```
Socket clientSocket =  
    newSocket("hostname", "port  
    number");
```

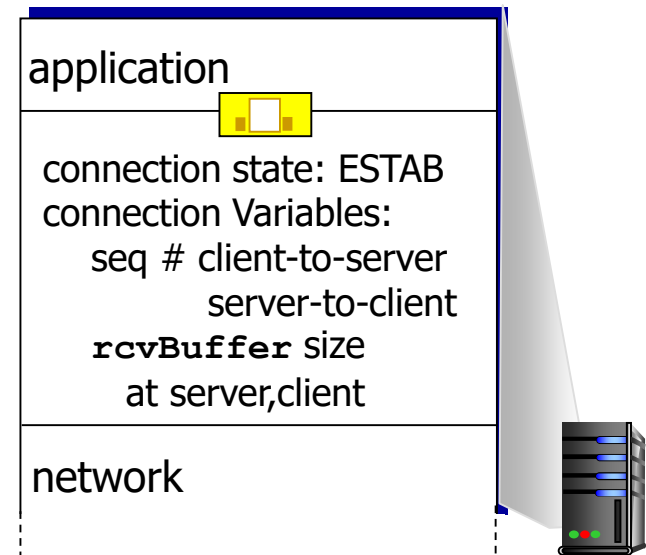

```
Socket connectionSocket =  
    welcomeSocket.accept();
```

Agreeing to establish a connection

2-way handshake:

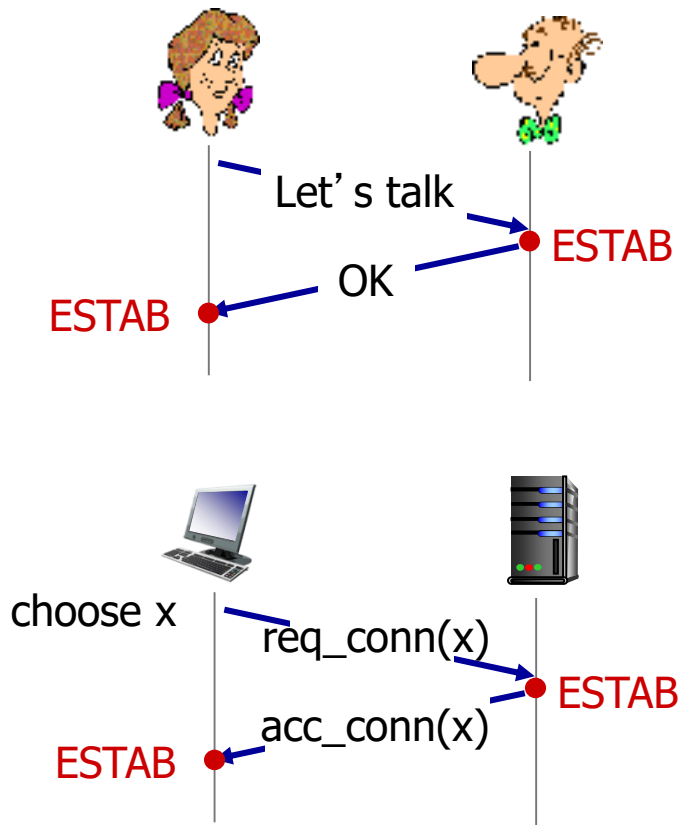

Q: will 2-way handshake always work in network?

- variable delays
- retransmitted messages (e.g. req_conn(x)) due to message loss
- message reordering
- can't "see" other side

Agreeing to establish a connection

2-way handshake failure scenarios:

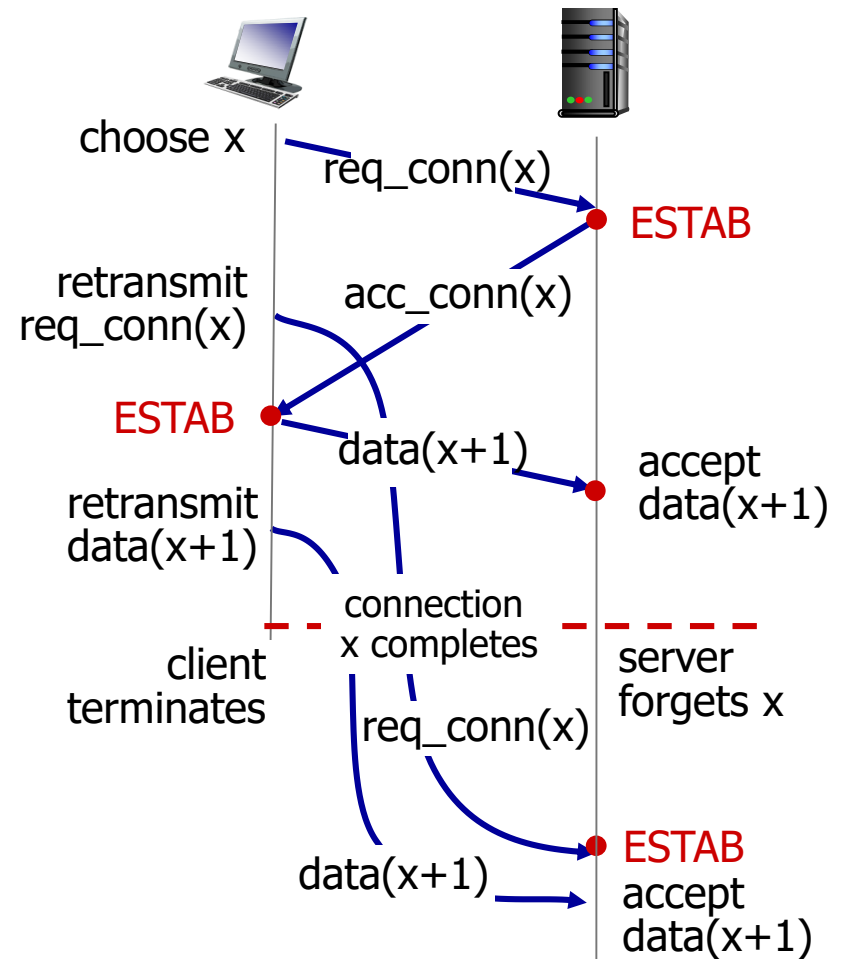
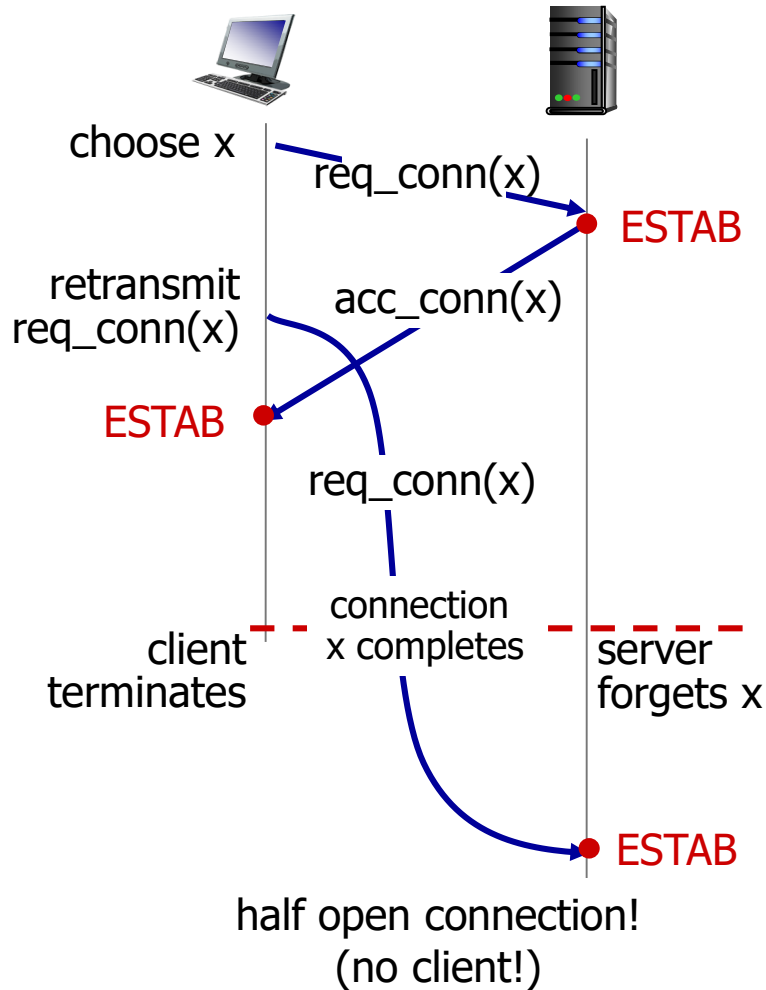

TCP 3-way handshake

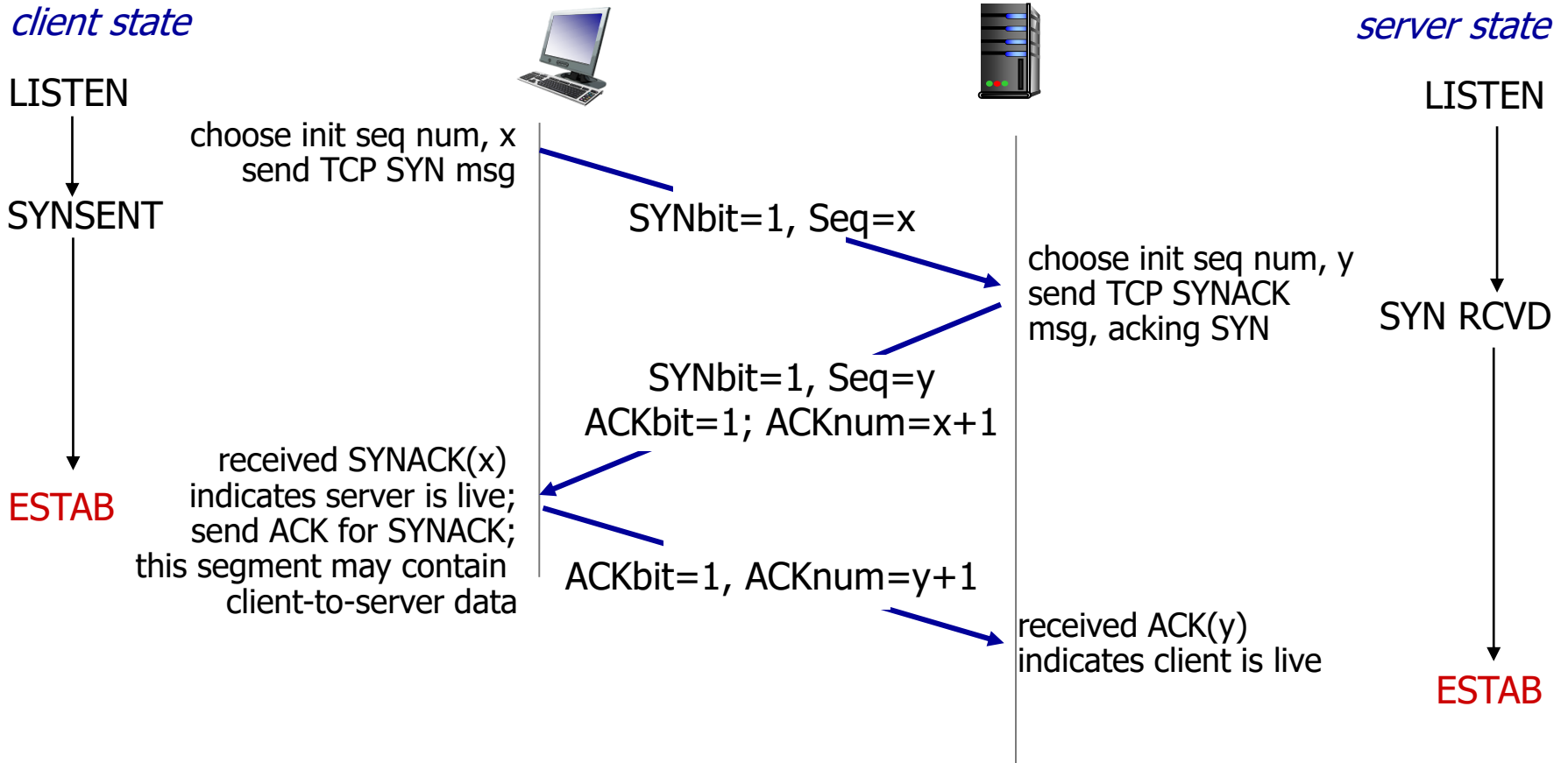

TCP 3-way handshake: FSM

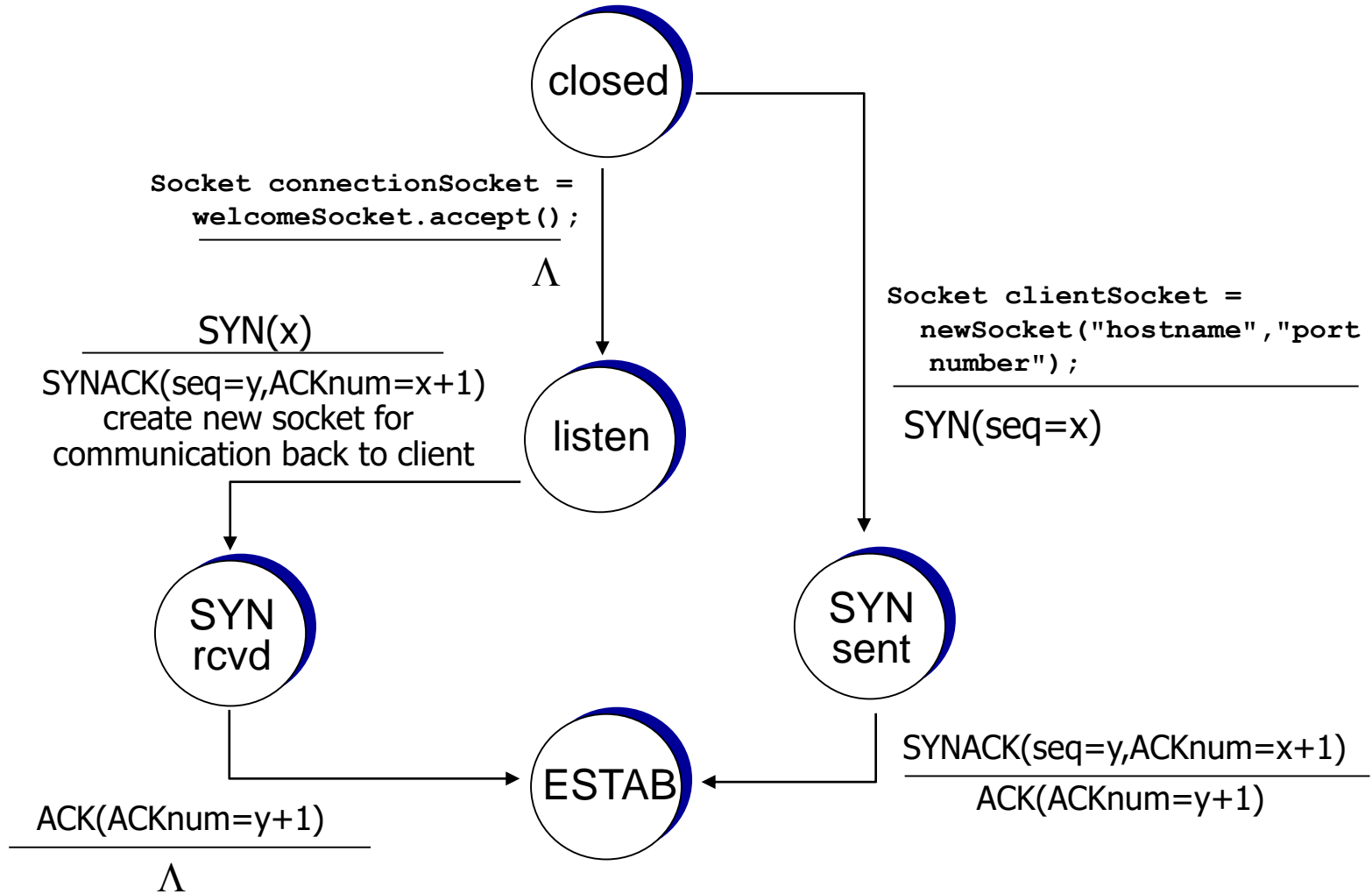

TCP: closing a connection

- client, server each close their side of connection
 - send TCP segment with FIN bit = 1
- respond to received FIN with ACK
 - on receiving FIN, ACK can be combined with own FIN
- simultaneous FIN exchanges can be handled

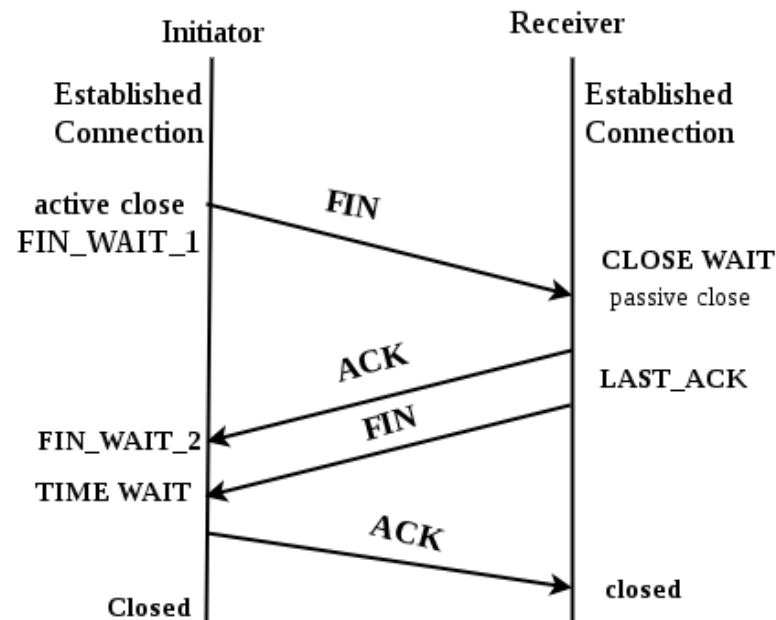

TCP: closing a connection

client state

ESTAB

`clientSocket.close()`

FIN_WAIT_1

can no longer
send but can
receive data

FIN_WAIT_2

wait for server
close

TIMED_WAIT

timed wait
for $2 * \text{max}$
segment lifetime

CLOSED



FINbit=1, seq=x

ACKbit=1; ACKnum=x+1

FINbit=1, seq=y

ACKbit=1; ACKnum=y+1

can still
send data

can no longer
send data

server state

ESTAB

CLOSE_WAIT

LAST_ACK

CLOSED

Chapter 3 outline

3.1 transport-layer services

3.2 multiplexing and demultiplexing

3.3 connectionless transport: UDP

3.4 principles of reliable data transfer

3.5 connection-oriented transport: TCP

- segment structure
- reliable data transfer
- flow control
- connection management

3.6 principles of congestion control

3.7 TCP congestion control

Principles of congestion control

congestion:

- informally: “too many sources sending too much data too fast for *network* to handle”
- different from flow control!
- manifestations:
 - lost packets (buffer overflow at routers)
 - long delays (queueing in router buffers)
- a top-10 problem!

Causes/costs of congestion: scenario I

- two senders, two receivers
- one router, infinite buffers
- output link capacity: R
- no retransmission

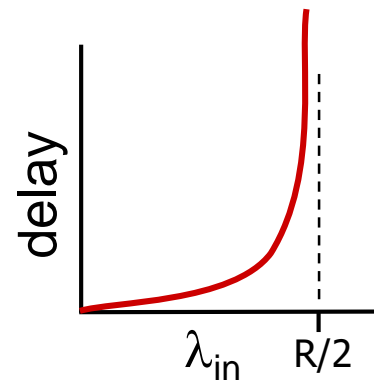
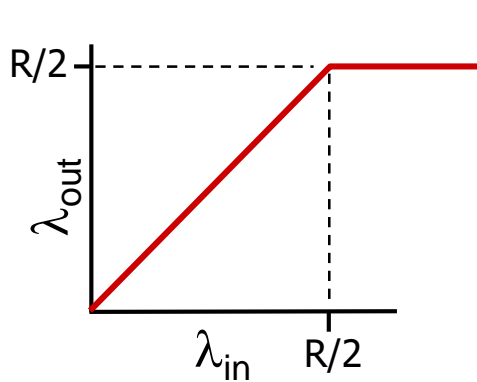
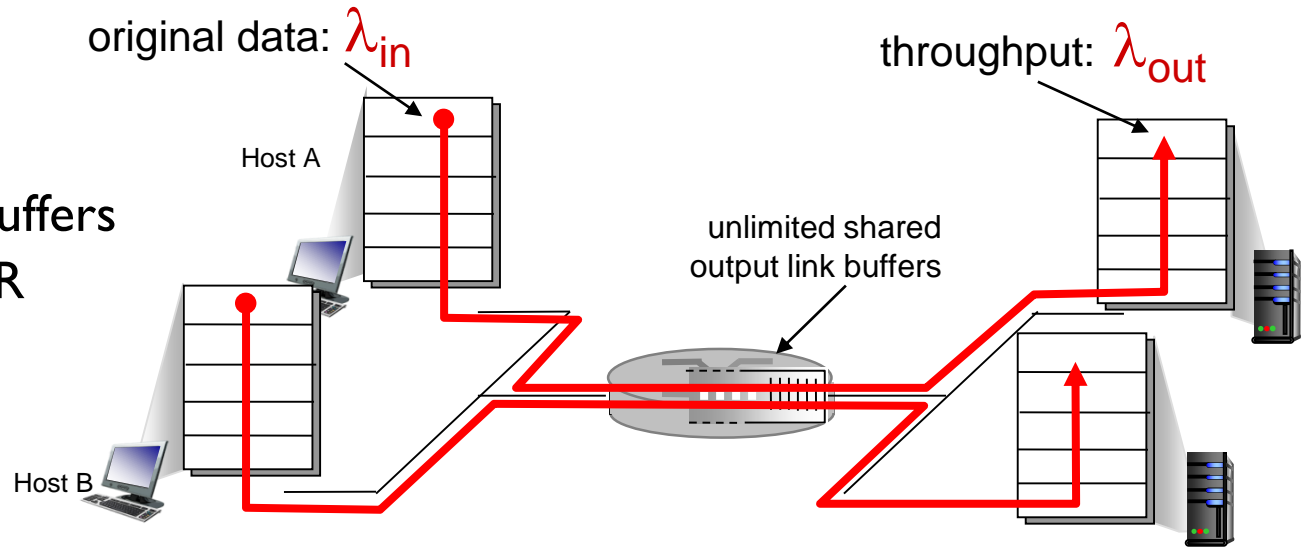

- maximum per-connection throughput: $R/2$
- ❖ large delays as arrival rate, λ_{in} , approaches capacity

Causes/costs of congestion: scenario 2

- one router, *finite* buffers
- sender retransmission of timed-out packet
 - application-layer input = application-layer output: $\lambda_{in} = \lambda_{out}$
 - transport-layer input includes *retransmissions* : $\lambda'_{in} \geq \lambda_{in}$

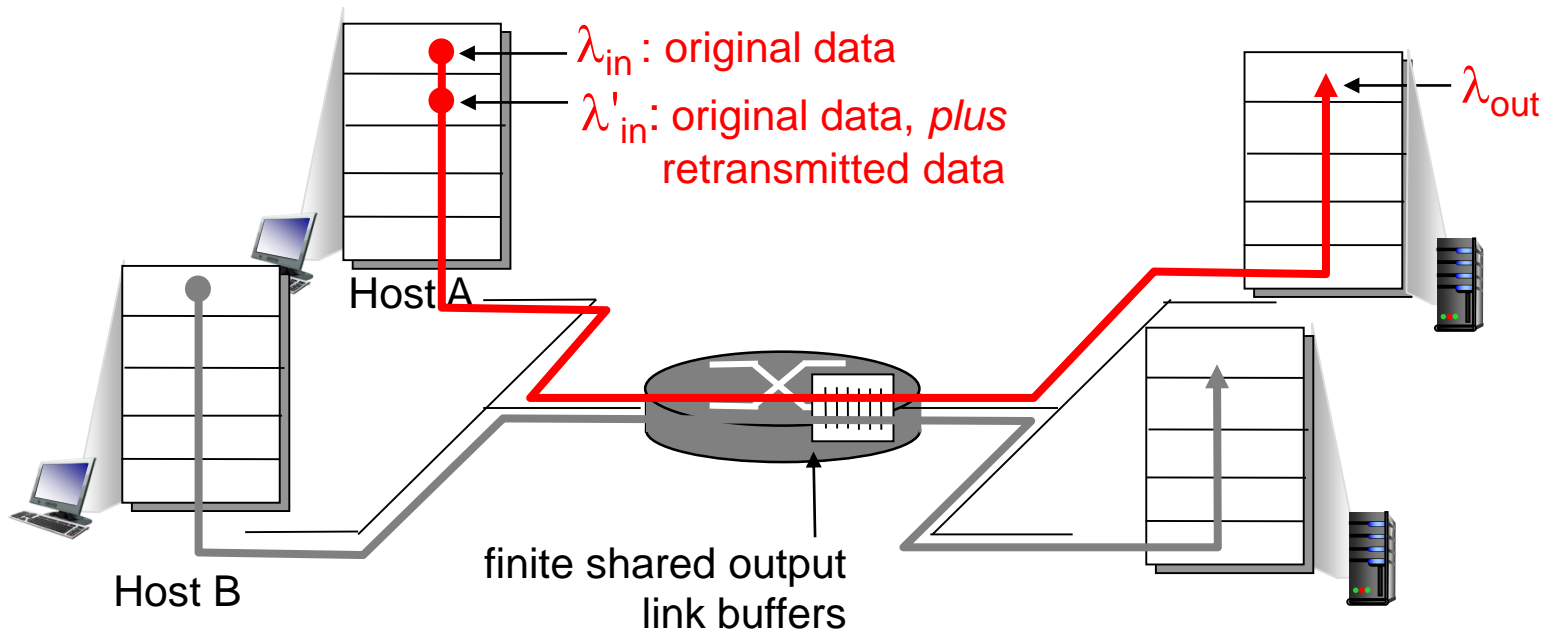

Causes/costs of congestion: scenario 2

idealization: perfect knowledge

- sender sends only when router buffers available

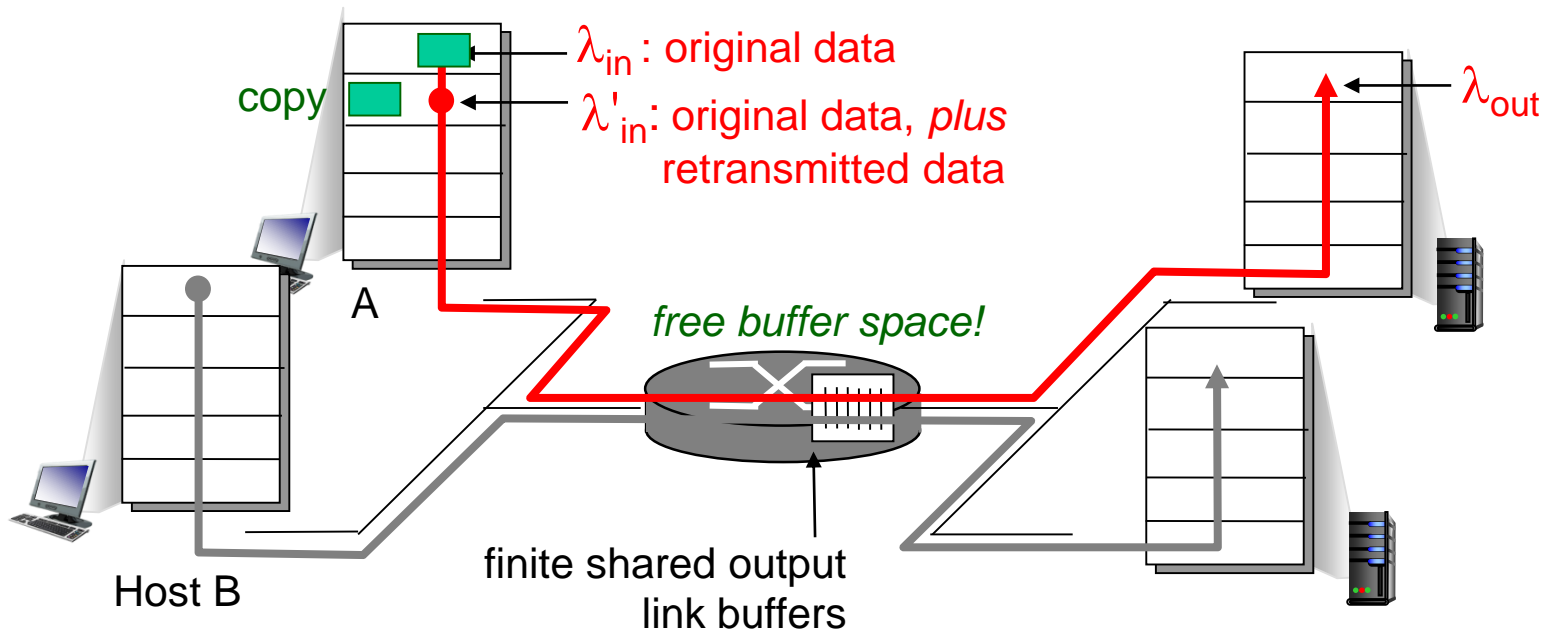
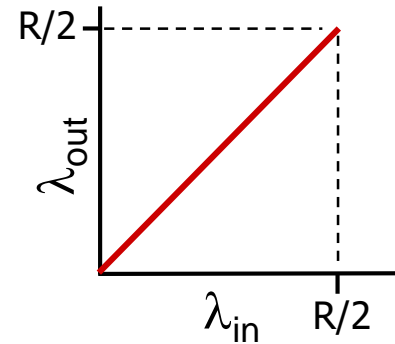

Causes/costs of congestion: scenario 2

Idealization: known loss

packets can be lost,
dropped at router due
to full buffers

- sender only resends if
packet *known* to be lost

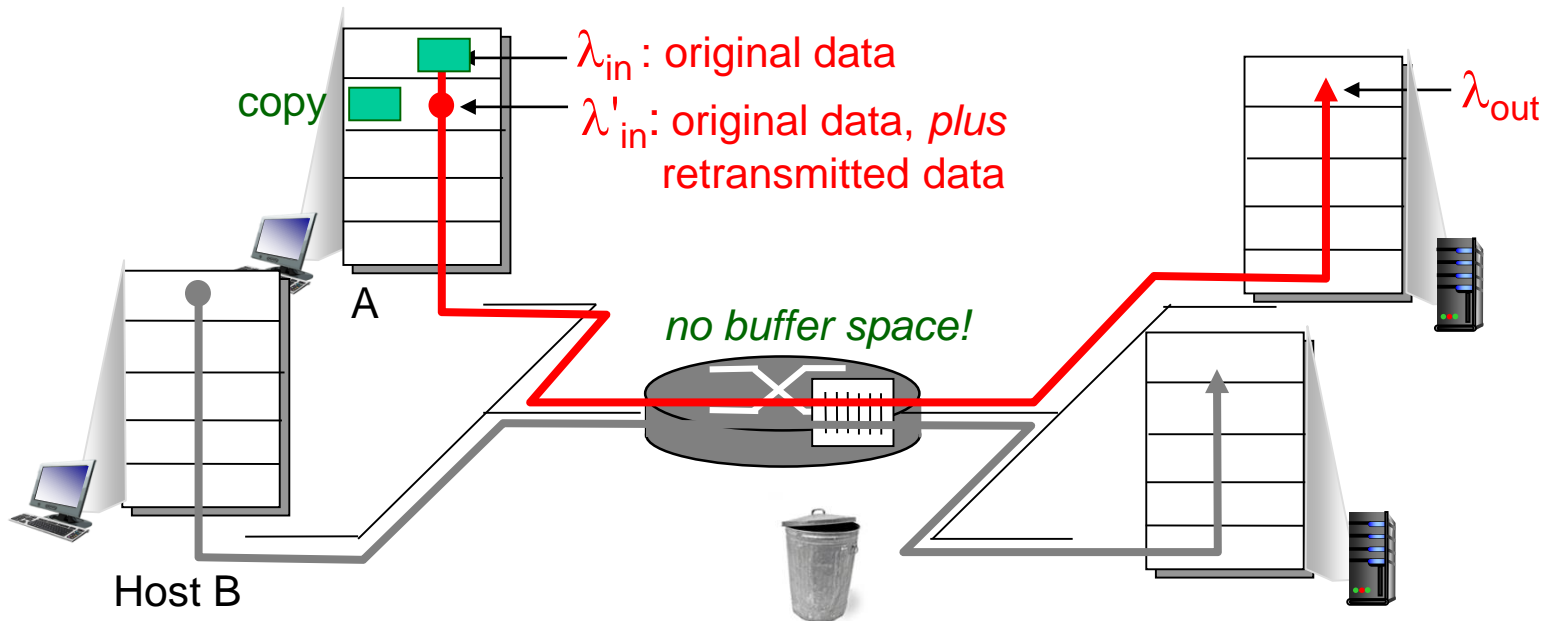

Causes/costs of congestion: scenario 2

Idealization: known loss

packets can be lost, dropped at router due to full buffers

- sender only resends if packet *known* to be lost

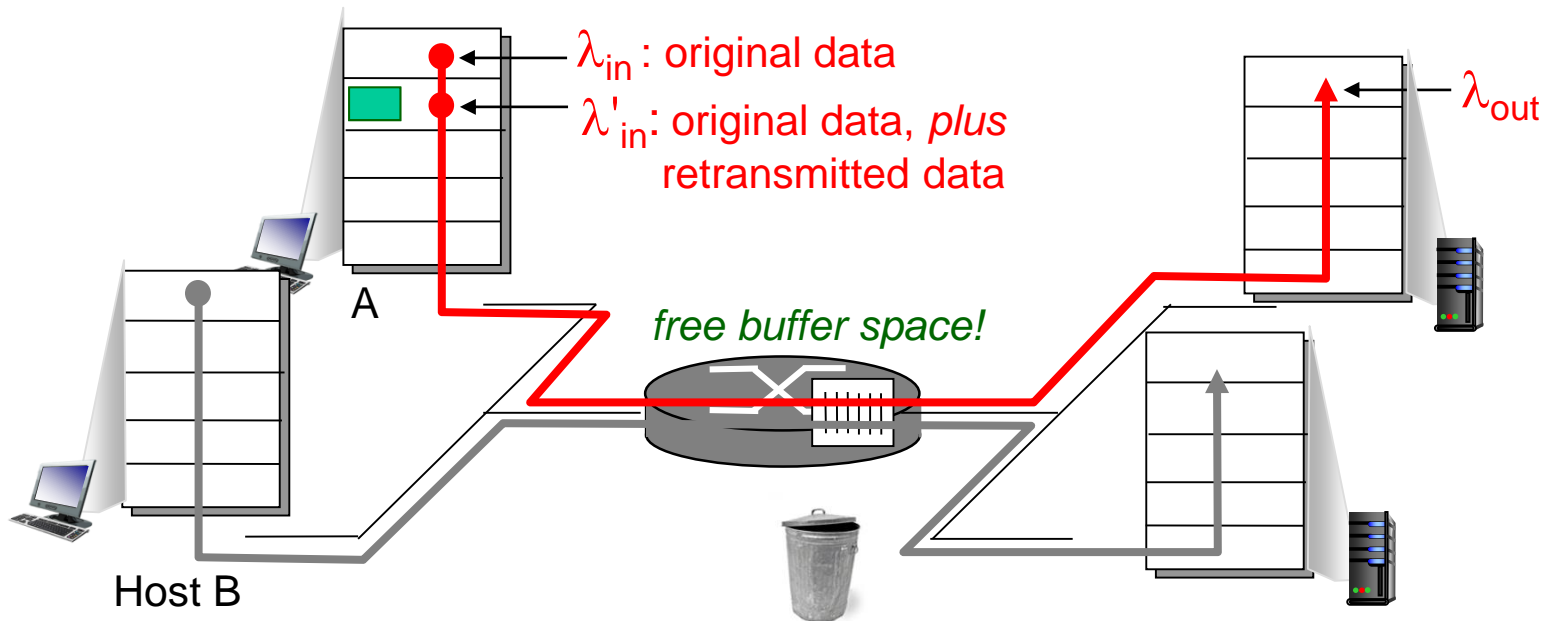
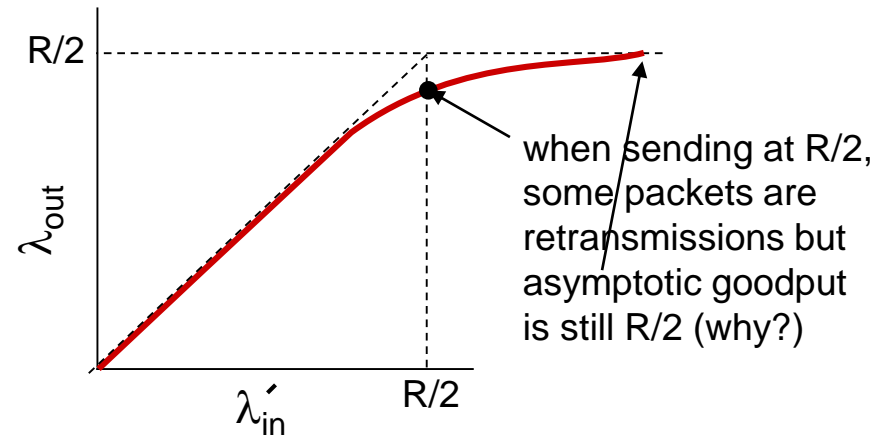

Causes/costs of congestion: scenario 2

Realistic: *duplicates*

- packets can be lost, dropped at router due to full buffers
- sender times out prematurely, sending *two* copies, both of which are delivered

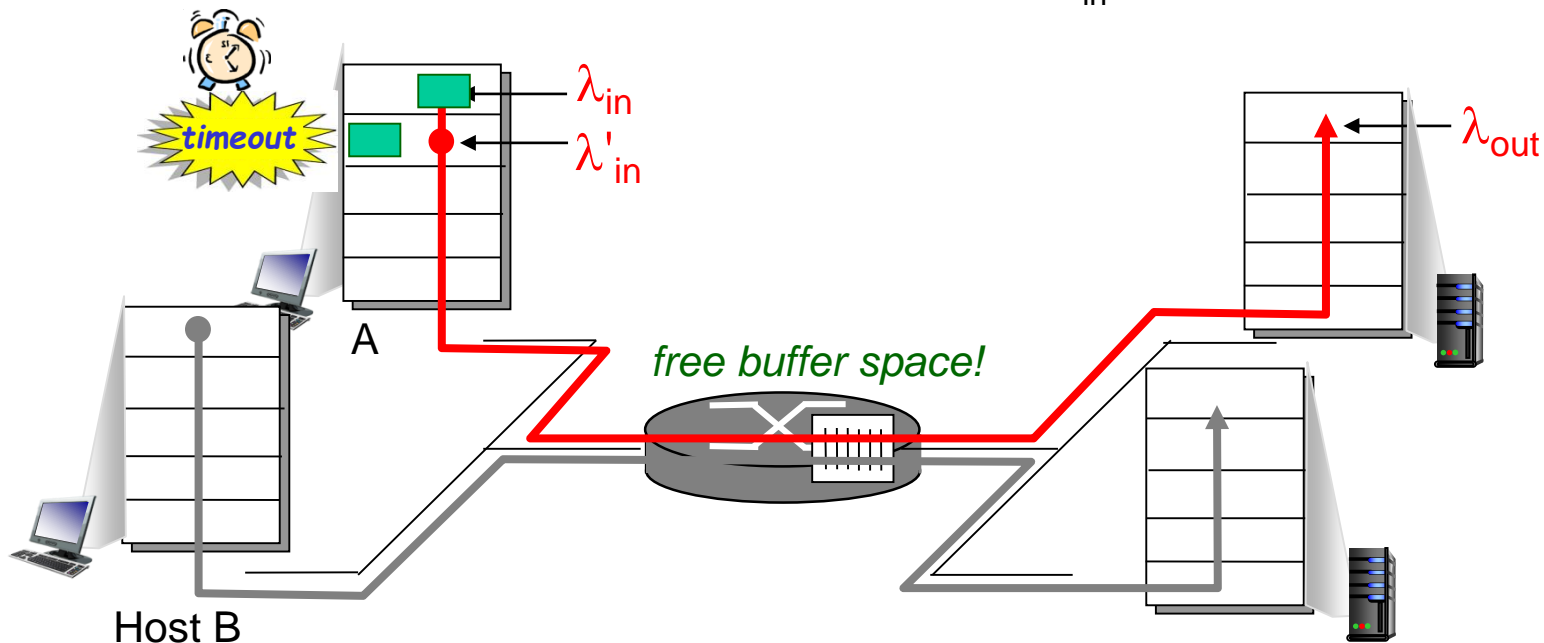
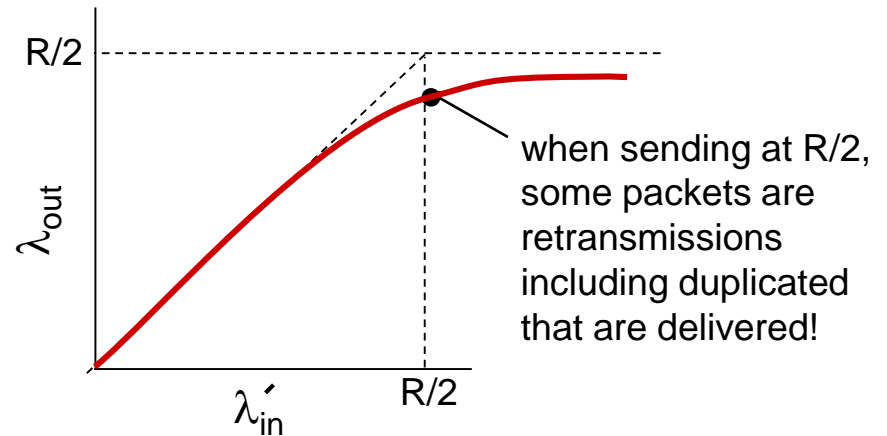

Causes/costs of congestion: scenario 2

Realistic: *duplicates*

- packets can be lost, dropped at router due to full buffers
- sender times out prematurely, sending *two* copies, both of which are delivered

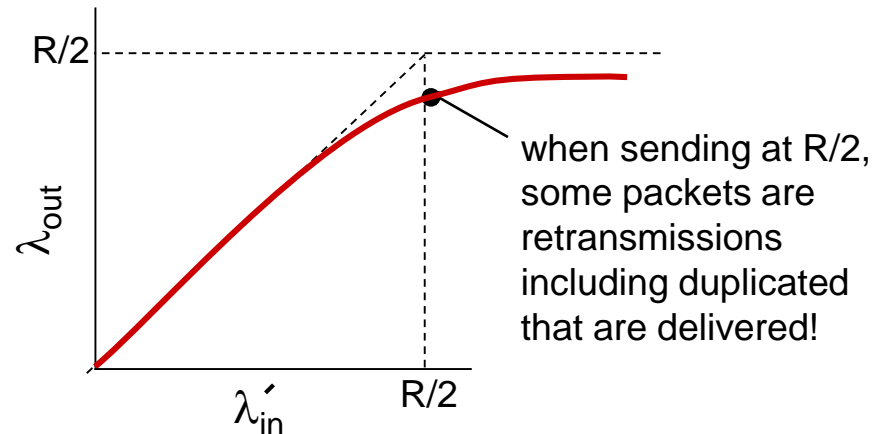

“costs” of congestion:

- more work (retrans) for given “goodput”
- unneeded retransmissions: link carries multiple copies of pkt
 - decreasing goodput

Causes/costs of congestion: scenario 3

- four senders
- multihop paths
- timeout/retransmit

Q: what happens as λ_{in} and λ'_{in} increase ?

A: as red λ'_{in} increases, all arriving blue pkts at upper queue are dropped, blue throughput $\rightarrow 0$

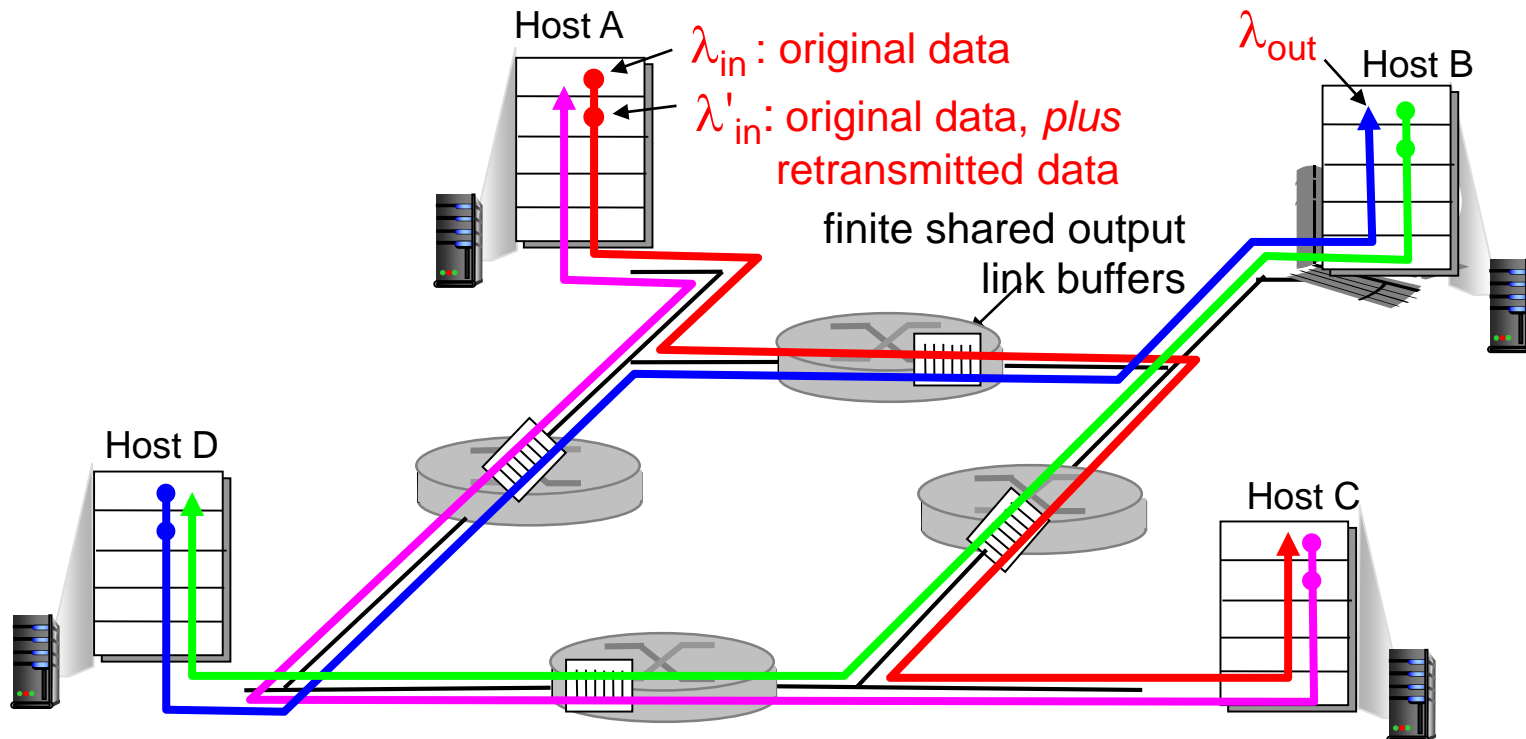

Causes/costs of congestion: scenario 3

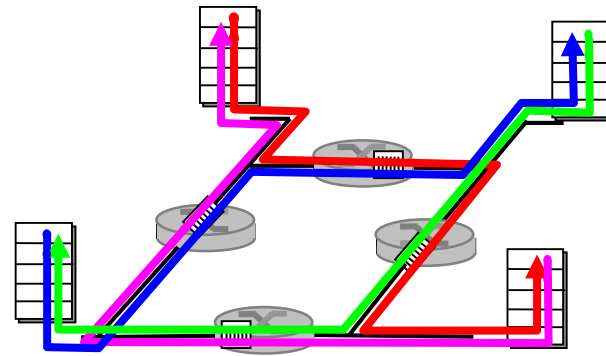
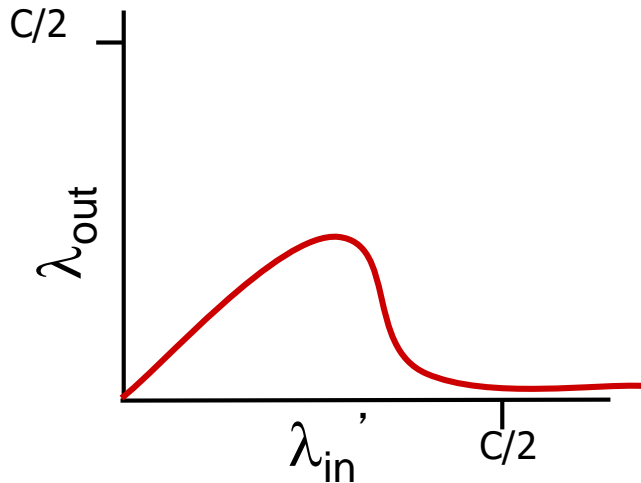

another “cost” of congestion:

- when packet dropped, any upstream transmission capacity used for that packet was wasted!

Chapter 3 outline

3.1 transport-layer services

3.2 multiplexing and demultiplexing

3.3 connectionless transport: UDP

3.4 principles of reliable data transfer

3.5 connection-oriented transport: TCP

- segment structure
- reliable data transfer
- flow control
- connection management

3.6 principles of congestion control

3.7 TCP congestion control

TCP congestion control: additive increase multiplicative decrease

- *approach*: sender increases transmission rate (window size), probing for usable bandwidth, until loss occurs
 - *additive increase*: increase **cwnd** by 1 MSS every RTT until loss detected
 - *multiplicative decrease*: cut **cwnd** in half after loss

AIMD saw tooth behavior: probing for bandwidth

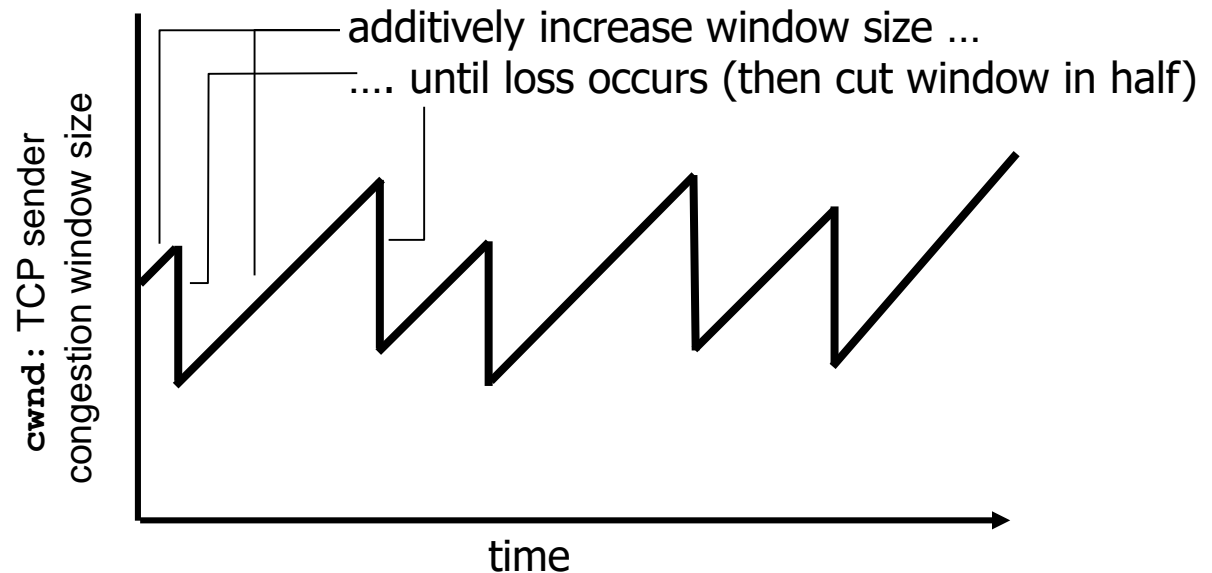

TCP Congestion Control: details

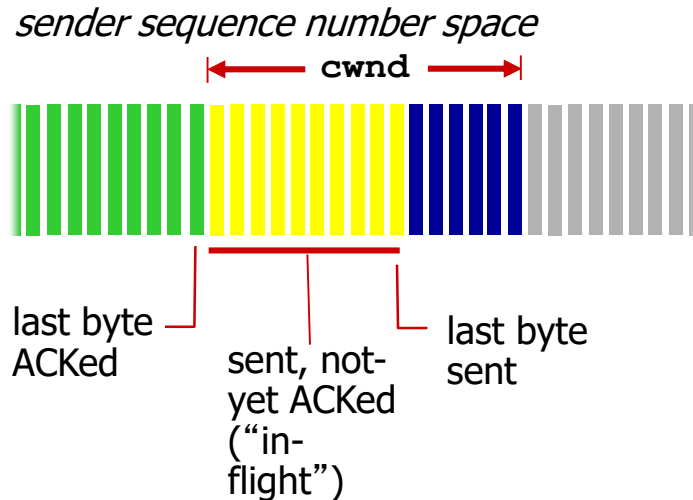

- sender limits transmission:

$$\text{LastByteSent} - \text{LastByteAked} \leq \text{cwnd}$$

- **cwnd** is dynamic, function of perceived network congestion

TCP sending rate:

- roughly: send cwnd bytes, wait RTT for ACKS, then send more bytes

$$\text{rate} \approx \frac{\text{cwnd}}{\text{RTT}} \text{ bytes/sec}$$

TCP Slow Start

- when connection begins, increase rate exponentially until first loss event:
 - initially `cwnd` = 1 MSS
 - double `cwnd` every RTT
 - done by incrementing `cwnd` for every ACK received
- summary: initial rate is slow but ramps up exponentially fast

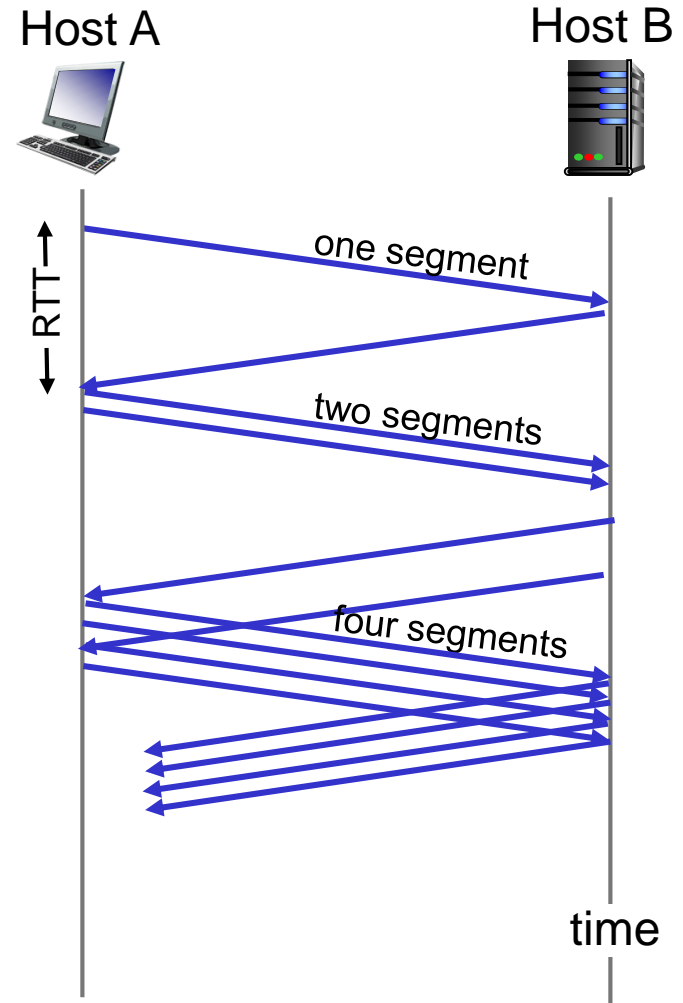

TCP: detecting, reacting to loss

- loss indicated by timeout:
 - **cwnd** set to 1 MSS;
 - window then grows exponentially (as in slow start) to threshold, then grows linearly
- loss indicated by 3 duplicate ACKs: **TCP RENO**
 - dup ACKs indicate network capable of delivering some segments
 - cwnd is cut in half window then grows linearly
- **TCP Tahoe** always sets cwnd to 1 (timeout or 3 duplicate acks)

TCP: switching from slow start to CA

Q: when should the exponential increase switch to linear?

A: when **cwnd** gets to 1/2 of its value before timeout.

Implementation:

- variable **ssthresh**
- on loss event, **ssthresh** is set to 1/2 of **cwnd** just before loss event

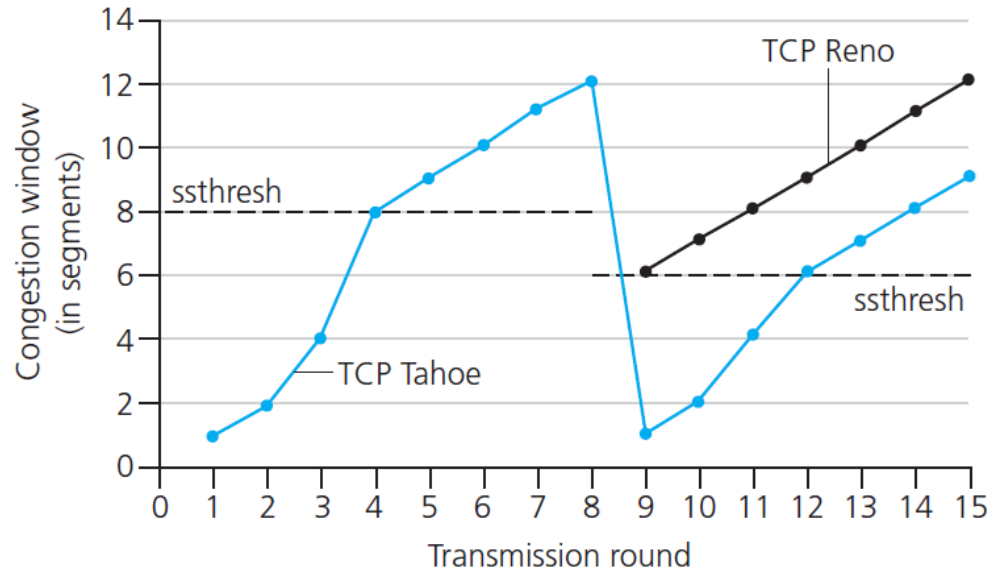

* Check out the online interactive exercises for more examples: http://gaia.cs.umass.edu/kurose_ross/interactive/

Summary: TCP Congestion Control

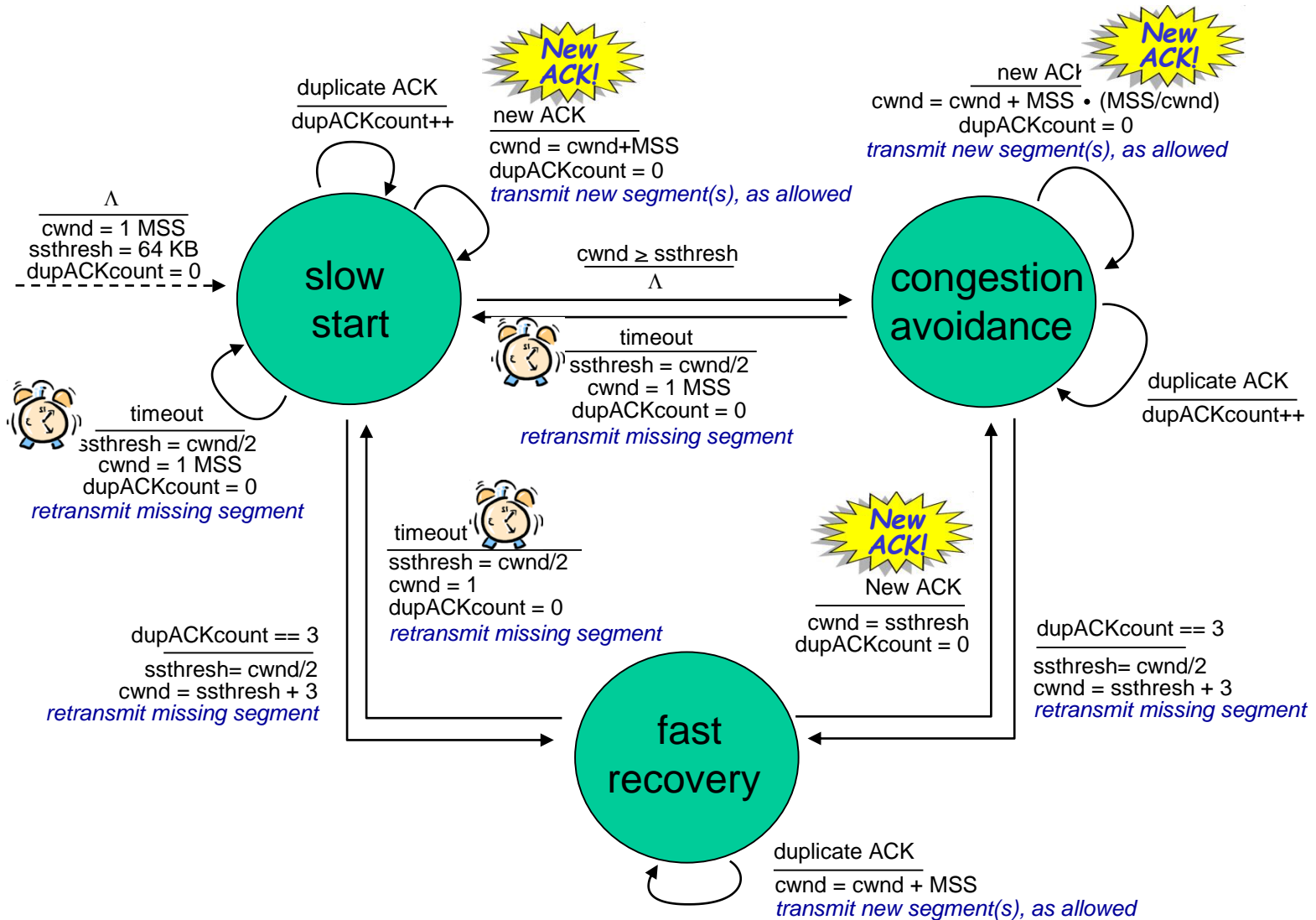

TCP throughput

- avg. TCP thruput as function of window size, RTT?
 - ignore slow start, assume always data to send
- **W: window size** (measured in bytes) where loss occurs
 - avg. window size (# in-flight bytes) is $\frac{3}{4} W$
 - avg. thruput is $\frac{3}{4}W$ per RTT

$$\text{avg TCP thruput} = \frac{3}{4} \frac{W}{\text{RTT}} \text{ bytes/sec}$$

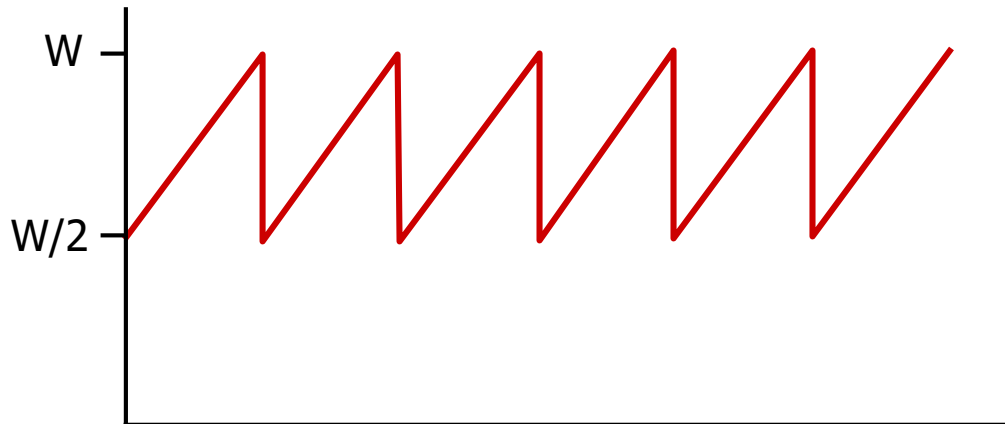

TCP Futures: TCP over “long, fat pipes”

- example: 1500 byte segments, 100ms RTT, want 10 Gbps throughput
- requires $W = 83,333$ in-flight segments
- throughput in terms of segment loss probability, L [Mathis 1997]:

$$\text{TCP throughput} = \frac{1.22 \cdot \text{MSS}}{\text{RTT} \sqrt{L}}$$

→ to achieve 10 Gbps throughput, need a loss rate of $L = 2 \cdot 10^{-10}$ – *a very small loss rate!*

- new versions of TCP for high-speed

TCP Fairness

fairness goal: if K TCP sessions share same bottleneck link of bandwidth R , each should have average rate of R/K

TCP connection 1

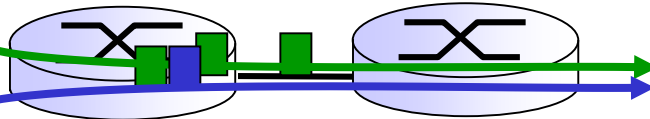

TCP connection 2



bottleneck
router
capacity R

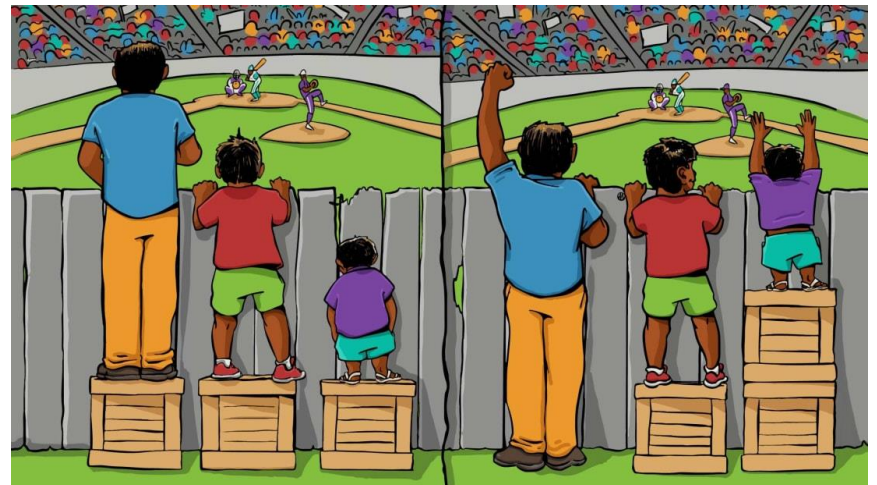

Why is TCP fair?

two competing sessions:

- additive increase gives slope of 1, as throughput increases
- multiplicative decrease decreases throughput proportionally

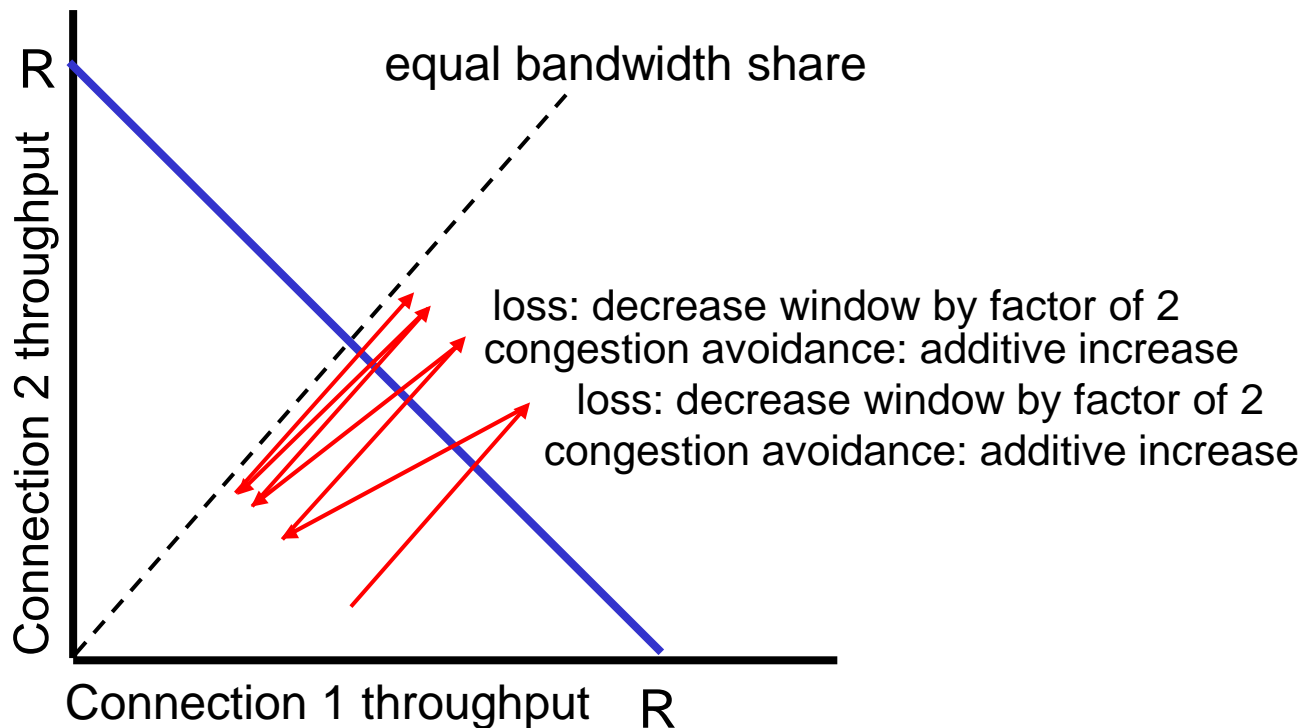

Fairness (more)

Fairness and UDP

- multimedia apps often do not use TCP
 - do not want rate throttled by congestion control
- instead use UDP:
 - send audio/video at constant rate, tolerate packet loss

Fairness, parallel TCP connections

- application can open multiple parallel connections between two hosts
- web browsers do this
- e.g., link of rate R with 9 existing connections:
 - new app asks for 1 TCP, gets rate $R/10$
 - new app asks for 11 TCPs, gets $R/2$

Explicit Congestion Notification (ECN)

network-assisted congestion control:

- two bits in IP header (ToS field) marked *by network router* to indicate congestion
- congestion indication carried to receiving host
- receiver (seeing congestion indication in IP datagram)) sets ECE bit on receiver-to-sender ACK segment to notify sender of congestion

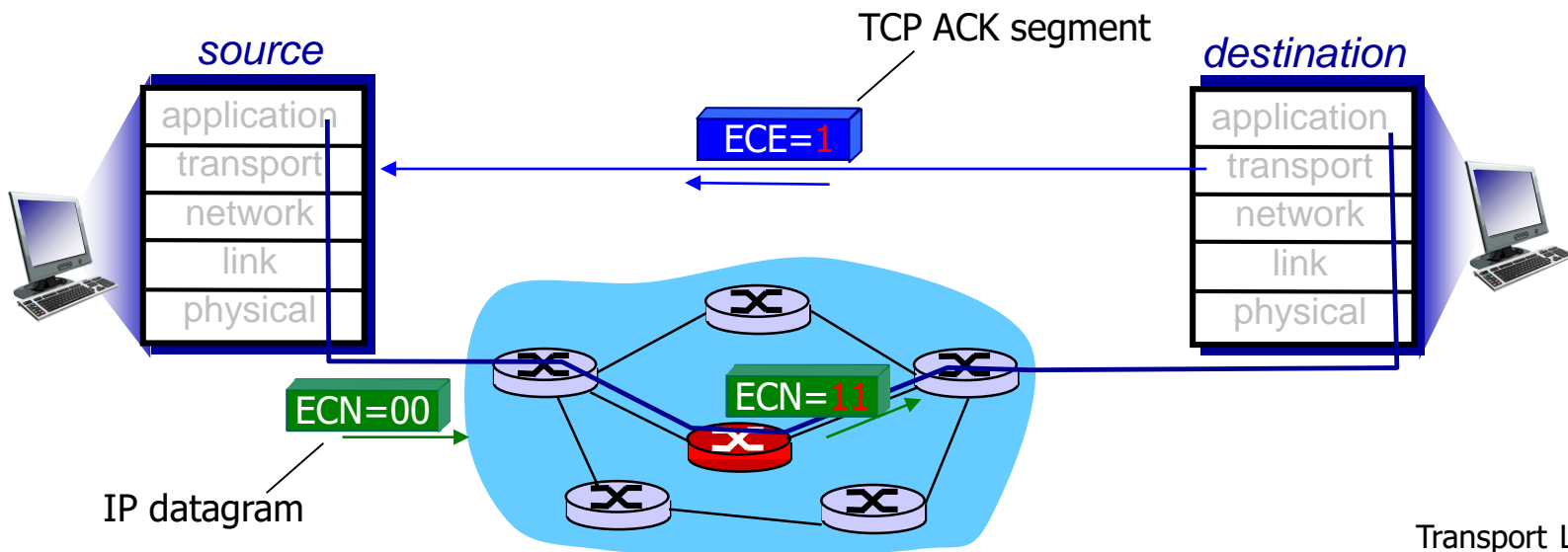

Chapter 3: summary

- principles behind transport layer services:
 - multiplexing, demultiplexing
 - reliable data transfer
 - flow control
 - congestion control
- instantiation, implementation in the Internet
 - UDP
 - TCP

next:

- leaving the network “edge” (application, transport layers)
- into the network “core”
- two network layer chapters:
 - data plane
 - control plane